

TC-U30

938

US Model
 Canadian Model
 AEP Model
 UK Model
 E Model
 SCN Model



'Dolby' and the double-D symbol are the trade marks of Dolby Laboratories. Noise reduction system manufactured under license from Dolby Laboratories.

STEREO CASSETTE DECK

SPECIFICATIONS

GENERAL

Power Requirements: US, Canadian model:
 120 V ac, 60 Hz
 AEP, SCN model:
 220 V ac ~, 50/60 Hz
 (or 240 V ac by internal rewiring)
 UK model:
 240 V ac ~, 50/60 Hz
 (or 220 V ac by internal rewiring)
 E model:
 110, 120, 220, 240 V ac ~, 50/60 Hz

Power Consumption: 15 W
Dimensions: Approx. 430 (w) x 135 (h) x 290 (d) mm
 17 (w) x 5¼ (h) x 11½ (d) inches
 including projecting parts and controls
Weight: Approx. 5.4 kg (11 lb 15 oz)

— Continued on page 2—

SAFETY RELATED COMPONENT WARNING!!

COMPONENTS IDENTIFIED BY SHADING AND MARK , ON THE SCHEMATIC DIAGRAMS, EXPLODED VIEWS AND IN THE PARTS LIST ARE CRITICAL TO SAFE OPERATION. REPLACE THESE COMPONENTS WITH SONY PARTS WHOSE PART NUMBERS APPEAR AS SHOWN IN THIS MANUAL OR IN SUPPLEMENTS PUBLISHED BY SONY.

ATTENTION AU COMPOSANT AYANT RAPPORT A LA SECURITE!

LES COMPOSANTS IDENTIFIES PAR UN TRAME ET UNE MARQUE , SUR LES DIAGRAMMES SCHEMATIQUES, LES VUES EXPLOSEES ET LA LISTE DES PIECES SONT CRITIQUES POUR LA SECURITE DE FONCTIONNEMENT. NE REMPLACER CES COMPOSANTS QUE PAR DES PIECES SONY DONT LES NUMEROS SONT DONNES DANS CE MANUEL OU DES SUPPLEMENTS PUBLIES PAR SONY.

Tape Transport Mechanism Type	TCM-91V2	
	Specification	Test Equipment
Forward Torque	30 – 50 g·cm (0.42 – 0.69 oz·inch)	Sony torque meter CQ-102
Fast Forward Torque	60 – 120 g·cm (0.84 – 1.66 oz·inch)	Sony torque meter CQ-201
Rewind Torque		
Back Tension Torque	2.0 – 4.5 g·cm (0.03 – 0.06 oz·inch)	Sony torque meter CQ-102
Pinch Roller Pressure	310 – 390 g (11 – 13 oz)	spring scale or tension gauge

SONY

SERVICE MANUAL

938

TC-U30

TAPE RECORDER SECTION

Recording System:	4-track 2-channel stereo	
Fast-forward and Rewind Time:	Approx. 90 sec. (with C-60)	
Frequency Response:	DOLBY NR OFF AEP, UK, E, SCN model: <ul style="list-style-type: none"> • With TYPE III cassette (Sony Fe-Cr) 30–15,000 Hz 50–13,000 Hz (±3 dB) 50–13,000 Hz (DIN) • With TYPE II cassette (Sony CD-α) 30–15,000 Hz 50–13,000 Hz (±3 dB) 50–13,000 Hz (DIN) • With TYPE I cassette (Sony BHF) 30–13,000 Hz US, Canadian model: <ul style="list-style-type: none"> • With TYPE III cassette (Sony Fe-Cr) 20–17,000 Hz 30–15,000 Hz (±3 dB) • With TYPE II cassette (Sony EHF) 20–17,000 Hz 30–15,000 Hz (±3 dB) • With TYPE I cassette (Sony HFX) 20–15,000 Hz 	<ul style="list-style-type: none"> • With TYPE II cassette (Sony CD-α) 54 dB at peak level (NAB) US, Canadian model: • With TYPE III cassette (Sony Fe-Cr) 58 dB at peak level • With TYPE II cassette (Sony EHF) 56 dB at peak level DOLBY NR ON Improved by 5 dB at 1 kHz, 10 dB above 5 kHz
Wow and Flutter:	0.05% WRMS (NAB) } (AEP, UK, E ±0.14% (DIN) } SCN model) 0.05% WRMS (US, Canadian model)	Total Harmonic Distortion: 1.7% (with Sony Fe-Cr cassette) Bias Frequency: 105 kHz Inputs: MIC (two phone jacks) sensitivity 0.25 mV (–70 dB) for a low-impedance microphone LINE IN (two phono plugs) sensitivity 77.5 mV (–20 dB) input impedance 50 kΩ Outputs: LINE OUT (two phono plugs) output level 0.435 V (–5 dB) at load impedance 50 kΩ suitable load impedance more than 10 kΩ Headphone output (binaural jack) output level –26 dB at load impedance 8Ω
S/N Ratio:	DOLBY NR OFF AEP, UK, E, SCN model: <ul style="list-style-type: none"> • With TYPE III cassette (Sony Fe-Cr) 56 dB at peak level (NAB) 55 dB (DIN, 1975 rev.) 	0 dB = 0.775 V

MODEL IDENTIFICATION

– Specification Label –

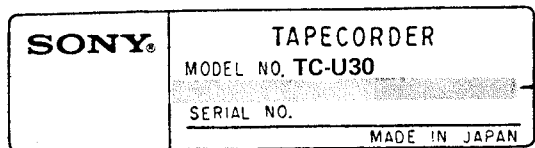

AC 120V 60Hz 15W ... US, Canadian model
 AC 220V~ 50/60Hz 15W ... AEP, SCN model
 AC 240V~ 50/60Hz 15W UK model
 AC 110, 120, 220, 240V 50/60Hz 15W.... E model

– Power Cord –

E1 model: euro-plug 1-551-896-00

E2 model: parallel-blade plug 1-551-628-00

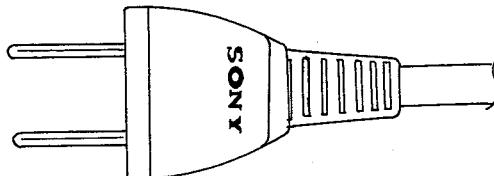
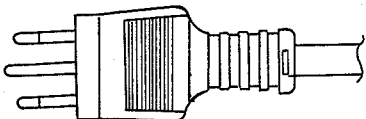

SECTION 1 OUTLINE

1-1. MECHANICAL OPERATION

Full-Auto Shut-Off Mechanism

When the end of the tape has been reached and the take-up reel stops rotating, shut-off lever (B) pushes against button-lock plate (A), thereby releasing the function buttons and bringing the motor to a stop.

Operation in Forward and Fast Forward Modes

(See Fig. 1-1.)

1. The mechanical parts rotate in the directions shown by the numbered arrows ① - ④.
2. Detecting lever (B) is pushed aside in the direction of arrow ⑤ due to the rotational action of the take-up reel.
3. The tip of detecting lever (B) is pushed into a central position (shown by dotted line) by the guide ⑥ of worm wheel. However, once the guide ⑥ has passed, the rotating take-up reel spindle pulls the detecting lever (B) back across to the right ⑤, thereby maintaining the forward (or fast forward) mode.

in forward or fast forward mode

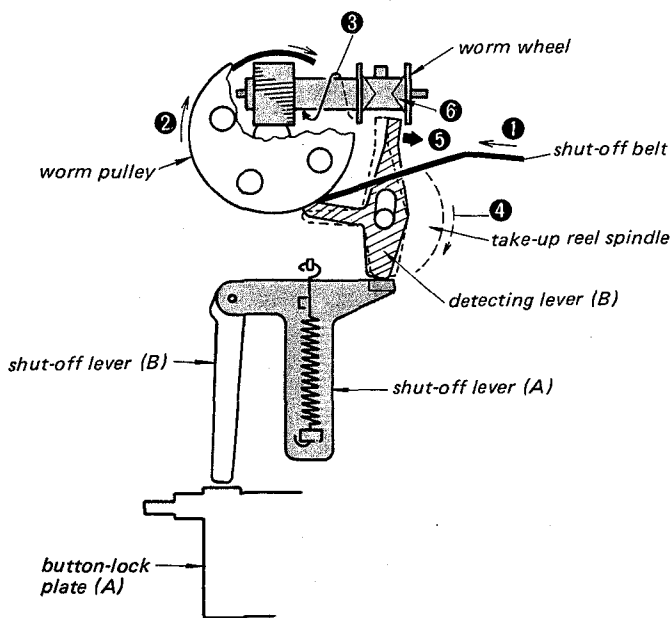

Fig. 1-1.

At the End of the Tape (in fast forward and forward modes)

When the take-up reel stops rotating, the worm wheel activates the automatic shut-off mechanism. This operation is made by shut-off lever (B) pushing against button-lock plate (A) as shown in Fig. 1-2.

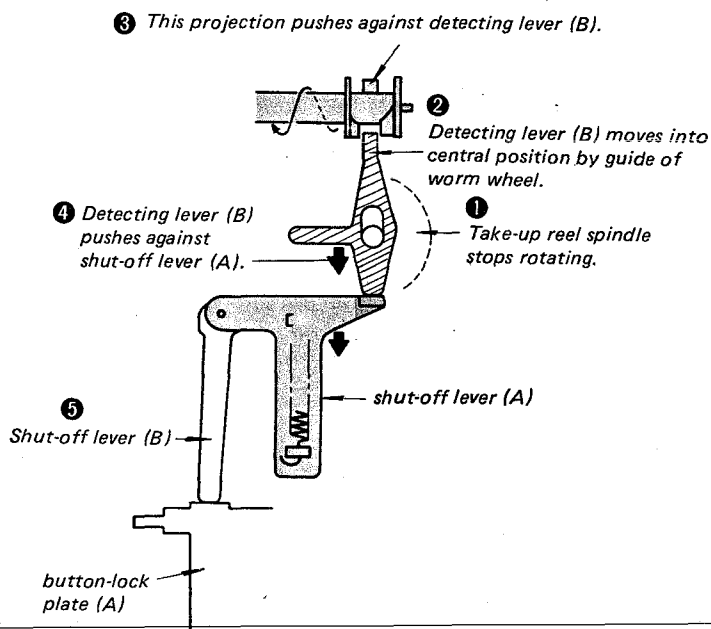

Fig. 1-2.

In Rewind Mode

The tip of detecting lever (B) is pushed to the left side of the worm wheel by the take-up reel rotating in the reverse direction. When the take-up reel stops rotating, button-lock plate (A) is pushed again back as in forward and fast forward modes, resulting in the release of the transport mode and stopping of the motor rotation.

Pause in Forward Mode

(See Fig. 1-3.)

As pause spring pushes detecting lever (B), the automatic shut-off mechanism does not operate.

in pause mode

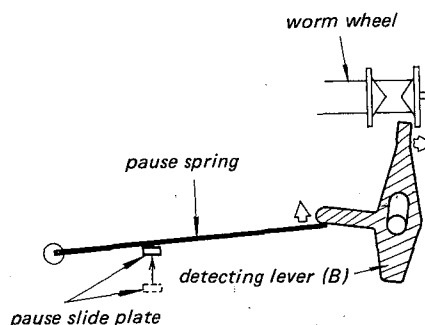

Fig. 1-3.

Auto-Play Mechanism

(See Fig. 1-4)

When the forward and rewind buttons are pressed at the same time, the tape deck is in rewind mode. When the tape has been wound onto supply reel and the reel stops rotating, only the rewind button is released, resulting in forward mode commencing automatically.

Note: When these two buttons are pressed at the same time, both forward and rewind modes are initiated. However, the auto-play lever prevents the pinch roller from pressing against the capstan. As a result, rewind mode will take priority. (The auto-play lever is not shown in Fig. 1-4.)

In Rewind Mode of Auto-Play Phase

(See Fig. 1-4.)

1. The FR lever pushes gear (A) to engage the flywheel gear, thereby driving the supply reel spindle, and resulting in rewinding of the tape.
2. The rod of the FR lever (C) displaces the button-lock plate spring (A) from its normal position, thereby separating button-lock plate (B) (E) from button-lock plate (A) (D).
3. The take-up reel spindle rotates in the direction shown by the arrow, thereby preventing the shut-off mechanism from being activated.

4. The auto-play lever prevents the pinch roller from pressing against the capstan, but the tape is near the head ready to commence forward mode.

At the End of Tape in Rewind Mode

1. When the take-up reel stops rotating, the shut-off mechanism is activated. The button-lock plate (A) is pushed back, and the rewind button consequently released.
2. Gear (A) disengages the flywheel gear, thereby releasing rewind mode.
3. Since the button-lock plate spring has been displaced by the FR lever rod, button-lock plate (B) employed to release the forward button will remain where it is at this time. Therefore, at the end of the rewind mode, only the rewind button is released. Forward mode is then commenced automatically.

At the End of Tape in Forward Mode

1. The FR lever rod is withdrawn as soon as forward mode is commenced. Consequently, the both button-lock plates (A) and (B) are engaged again by the button-lock plate spring.
2. When the shut-off mechanism is activated again at the end of tape in forward mode, both button-lock plates (A) and (B) are pushed back by FR lever rod, thereby bringing all transport mechanism to a complete stop mode.

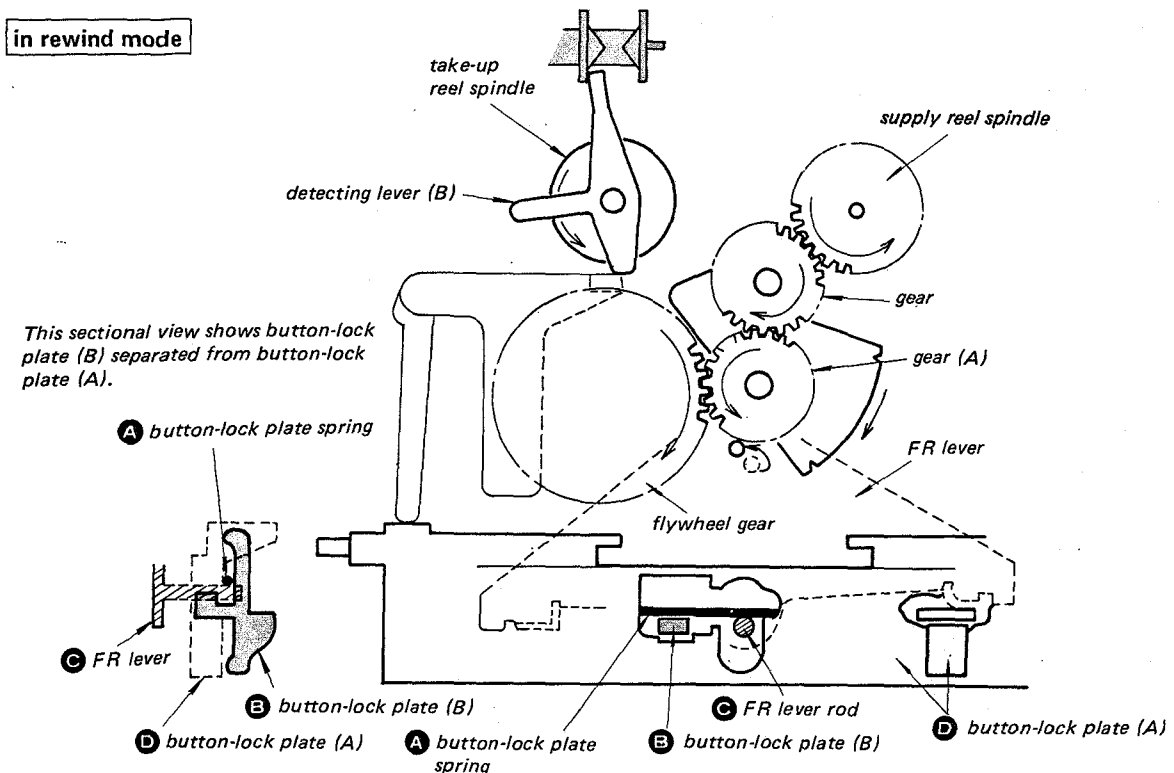

Fig. 1-4.

Timer Standby Mechanism

The timer standby switch permits playback or record mode to be commenced at desired time. With the power cord of the tape deck disconnected from the ac wall outlet, turn the power switch on, and press the forward button, or the forward and record buttons. Then, turn the timer standby switch on, and connect the tape deck to the ac wall outlet through a timer for the desired time.

At Standby

(See Fig. 1-5.)

1. The timer standby switch presses up against the timer standby levers (A) and (B).
2. The pause slide plate and release lever are thereby moved in the direction shown by the arrows marked ▲, resulting in the pinch roller being separated from the capstan.
3. The timer standby lever (B) presses up against the release lever (A), thereby separating the take-up arm pulley from the tire of the take-up reel spindle.
4. The timer standby lever (A) pushes timer standby lever (C) in the direction of arrow ①, thereby pushing shut-off lever (B) (employed to release function buttons) away from the button-lock plate (A).

at standby mode

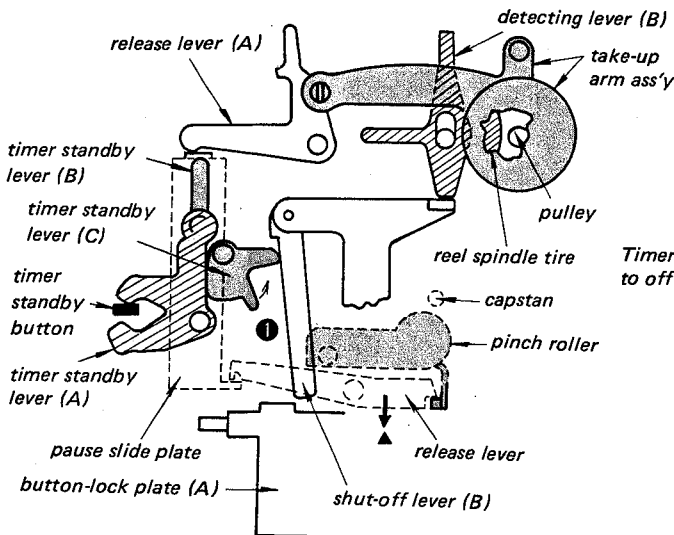

Fig. 1-5.

When Power is Switched On

(See Fig. 1-6.)

1. The motor starts to drive the worm wheel.
2. The worm wheel pushes against detecting lever (B).
3. The ■ marked section of shut-off lever (B) pushes against standby lever (C) as shown in Fig. 1-5.
4. The timer standby lever (C) pushes against standby lever (A), thereby returning the timer standby button to the off position.
5. The timer standby lever (B) and release lever (A) return to their original positions, thereby bringing the take-up arm to engage against the tire of the take-up reel spindle which is rotated by motor.
6. Since the pause slide plate and release lever also return to their original positions, the pinch roller presses against the capstan to start forward mode.

when power switched on

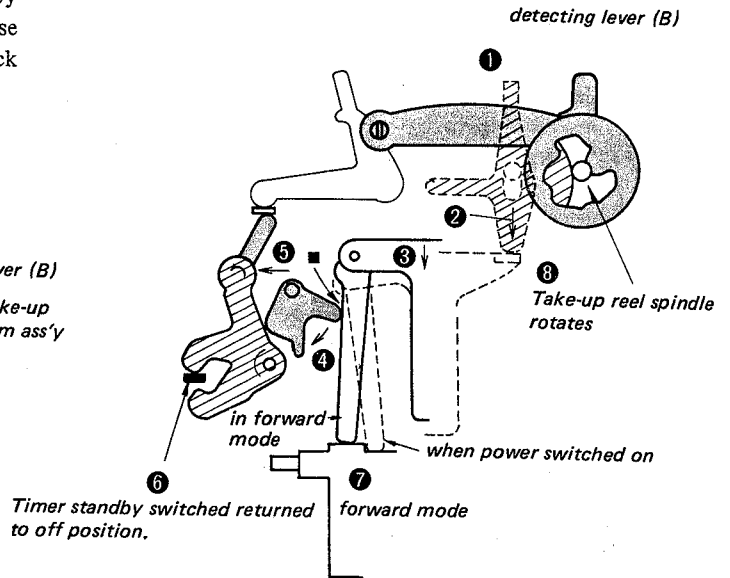

Fig. 1-6.

1-2. CIRCUIT OPERATION

This set is equipped with an LED peak program meter, which indicates the input signal level (as a bar graph).

The following explanations describe the operation of each of the circuit.

1. IC401 Input Circuit.

Input signal **A** (waveform **A**) is applied to IC302 in the LOG converter circuit. By the characteristic of a diode, the input signal is logarithmically compressed and waveform **A** changes into waveform **B**.

The peak of signal **B** is detected by D103 and smoothed by C162. Then it is applied to terminal **(11)** of IC401 as dc voltage (waveform **C**).

2. LED Indication Circuit

The LEDs turn on when the anode and the cathode signals drop to a LOW level at the same time.

ex) LINE OUT output -5dB

D, F : LOW level

↓
waveform **H** - **O** : anode, cathode: LOW level

↓
L-CH/R-CH : LEDs 1~8 turn on
(See Diagram 1.)

LED MATRIX DIAGRAM

anode signal \ cathode signal	R-CH		L-CH	
	D	E	F	G
H	1	9	1	9
I	2	10	2	10
J	3	11	3	11
K	4	12	4	12
L	5	13	5	13
M	6	14	6	14
N	7	15	7	15
O	8	16	8	16

Diagram 1.

(When either two of the signals **D** - **G** and of **H** - **O** drop to LOW level, the LEDs shown in the diagram turn on.)

Measuring Condition

LINE IN: 1 kHz, 0.25V (-10 dB)

LINE OUT: 0.44V (-5 dB)

Mode: record/forward

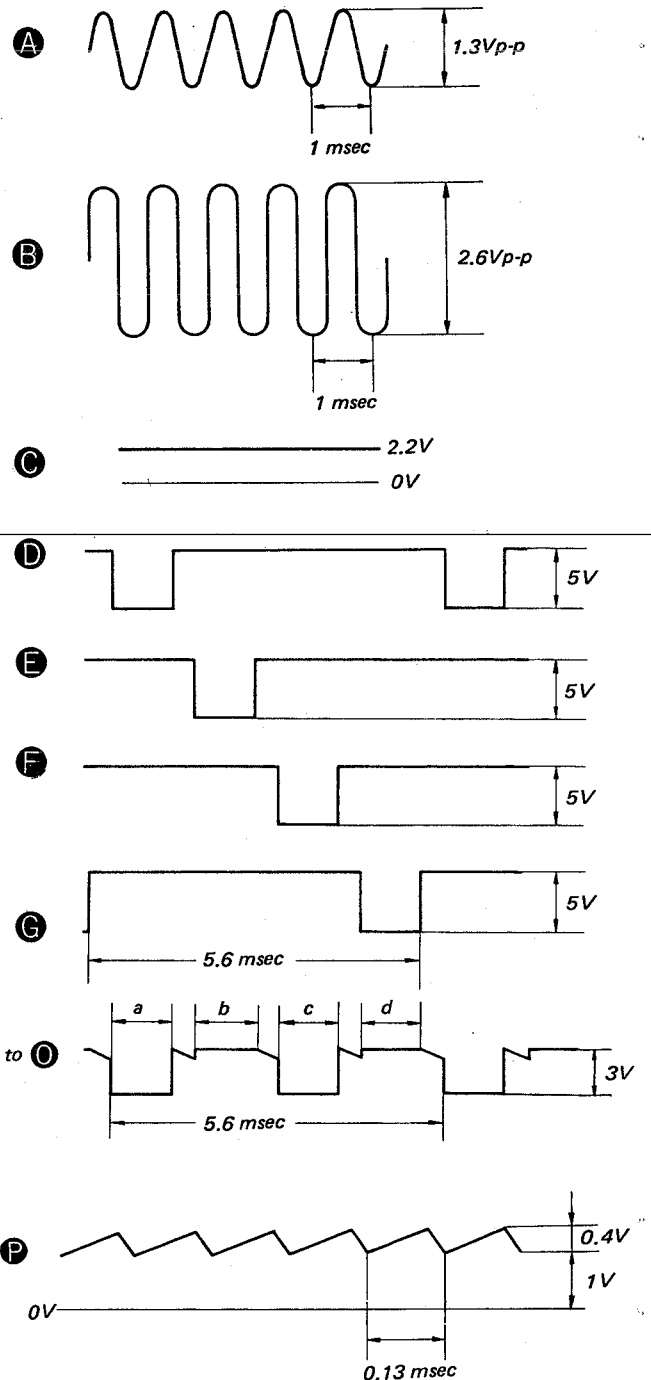

TC-U30 TC-U30

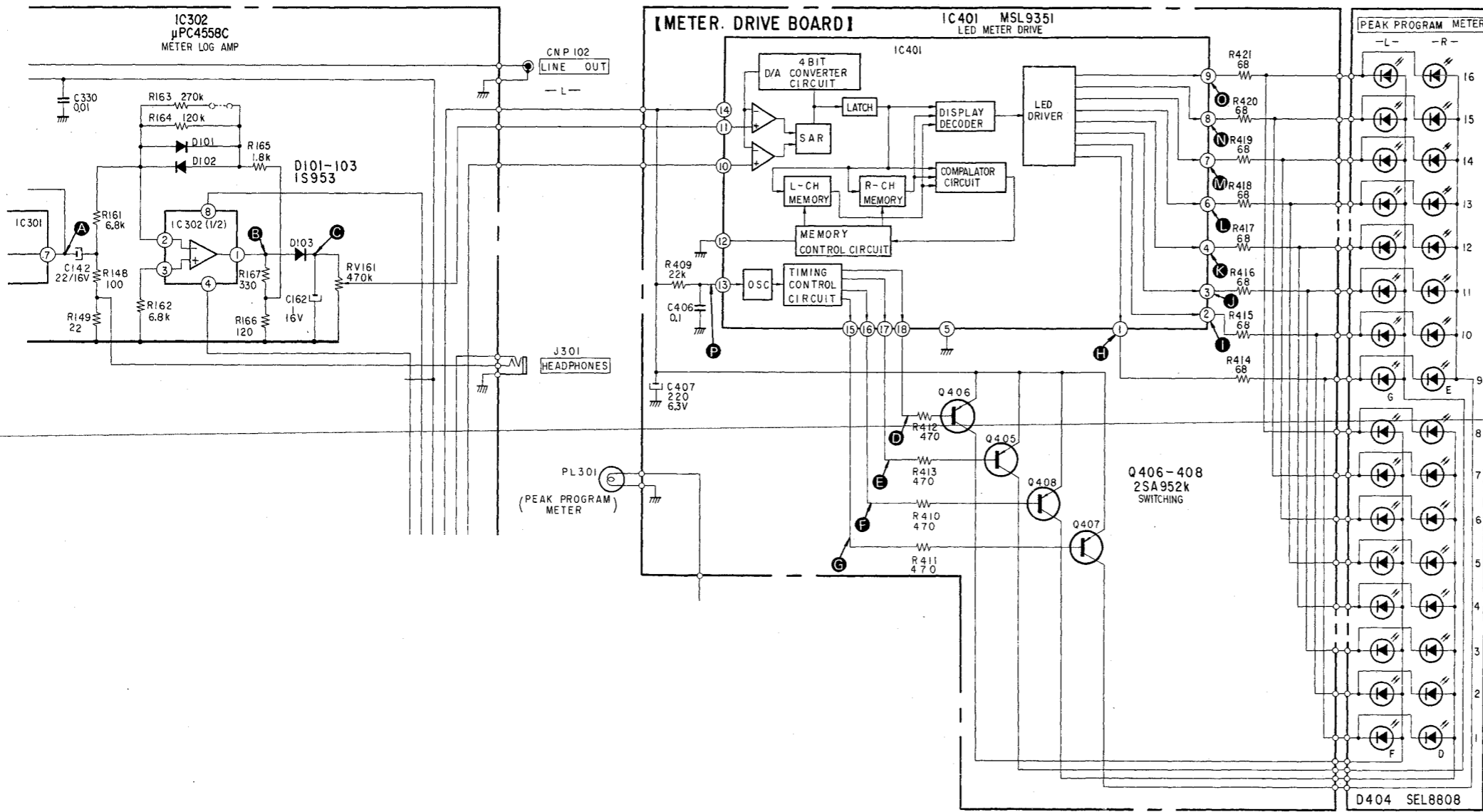

SECTION 2
DISASSEMBLY

Note: Follow the disassembly procedure in the numerical order given.

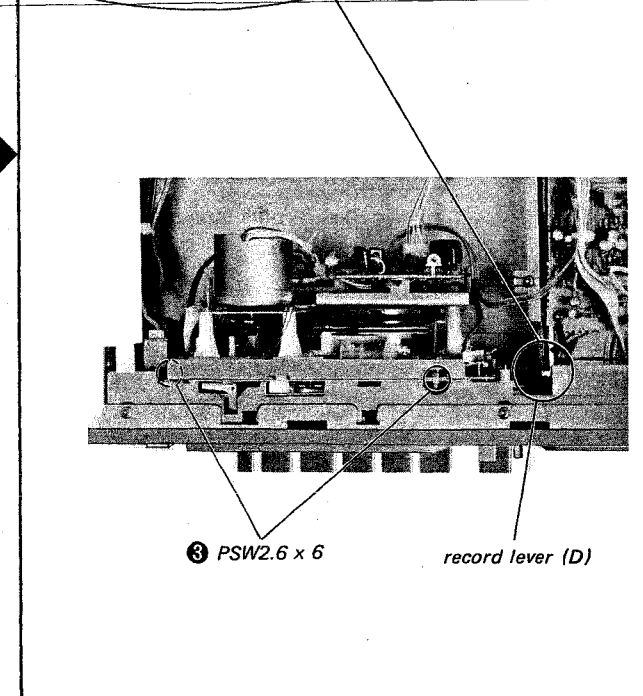
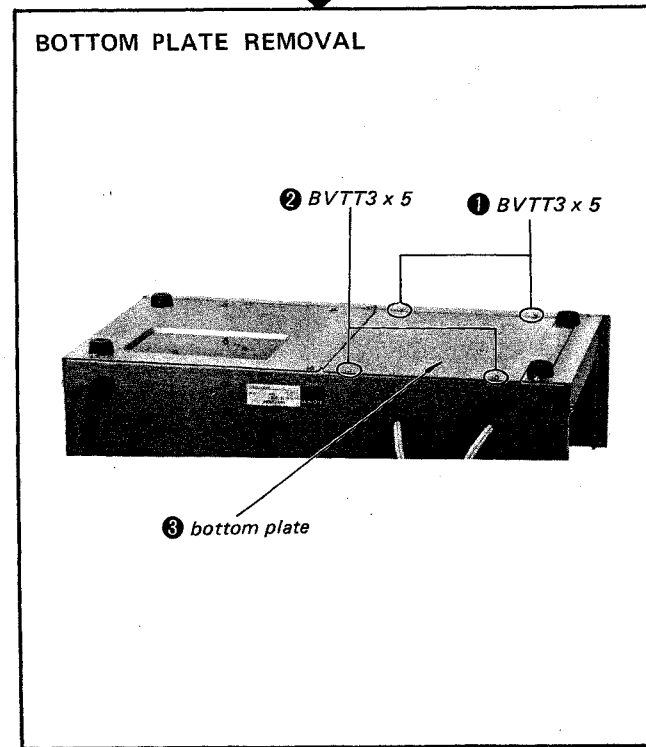
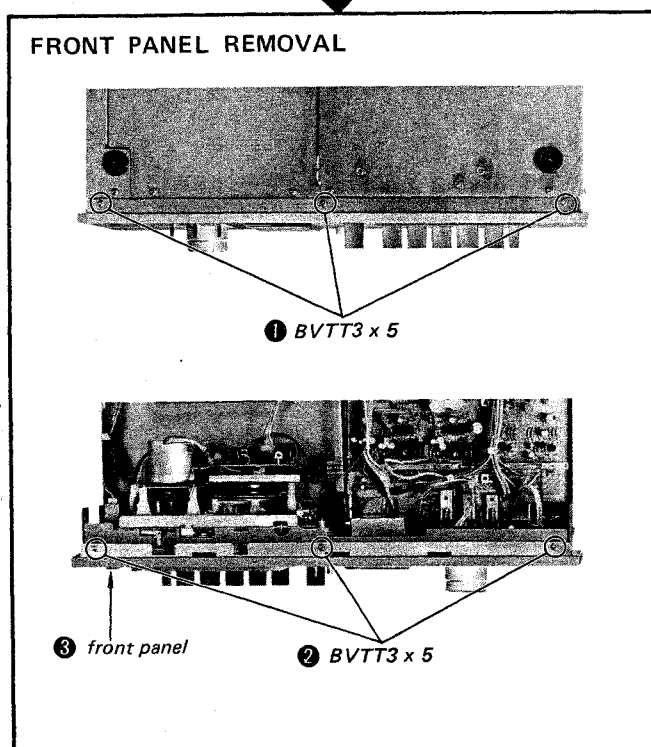
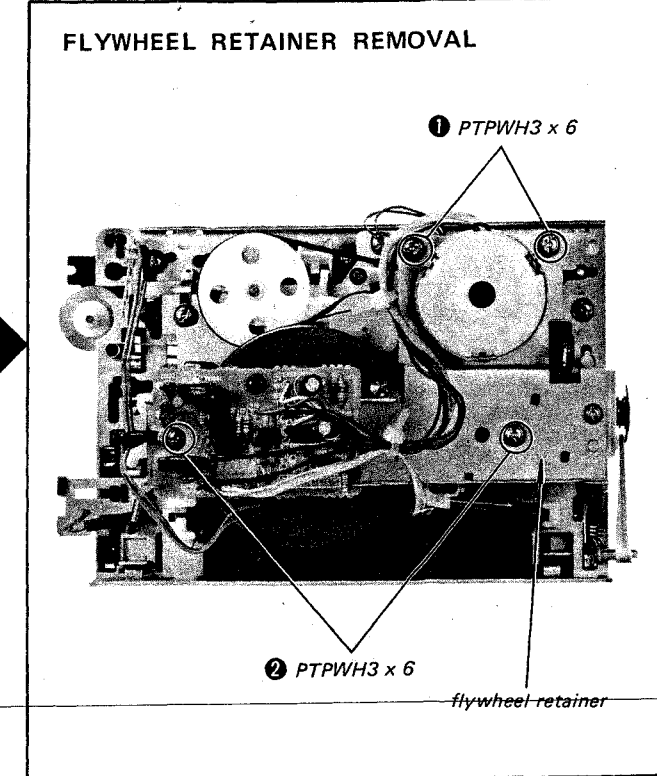
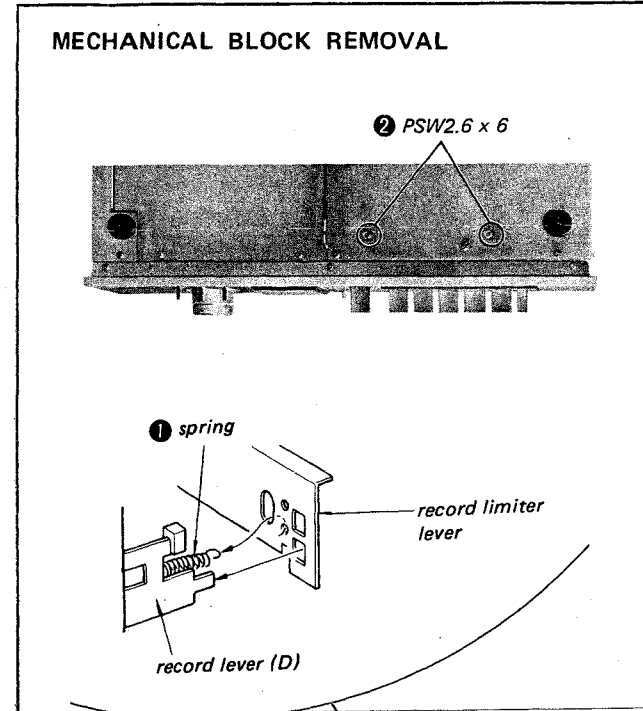
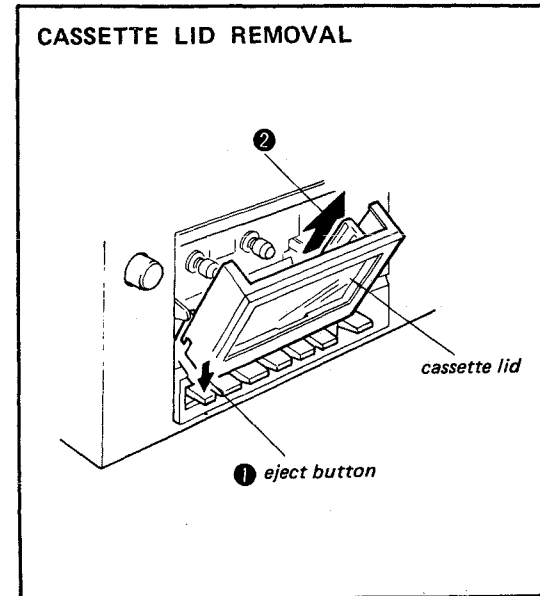
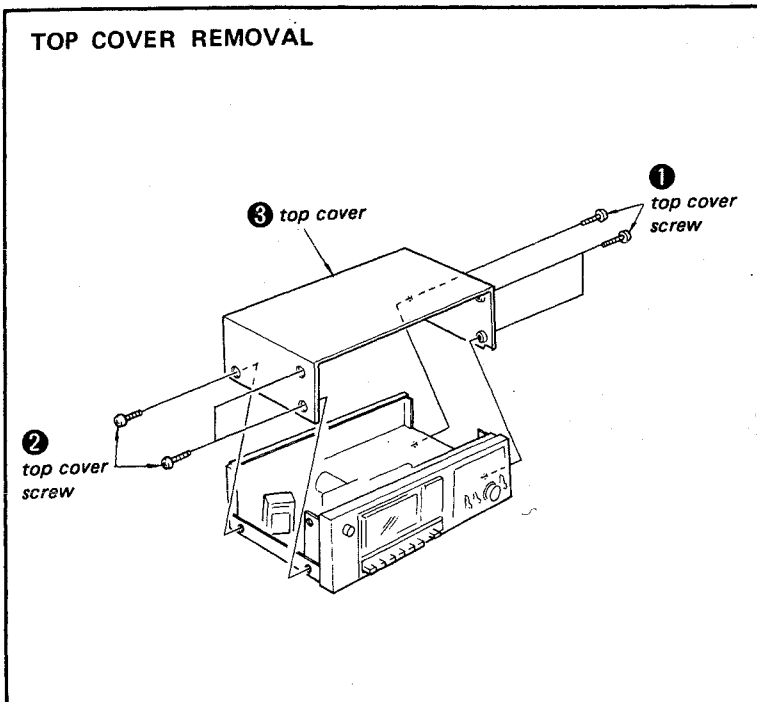

REEL SPINDLE BASE REMOVAL

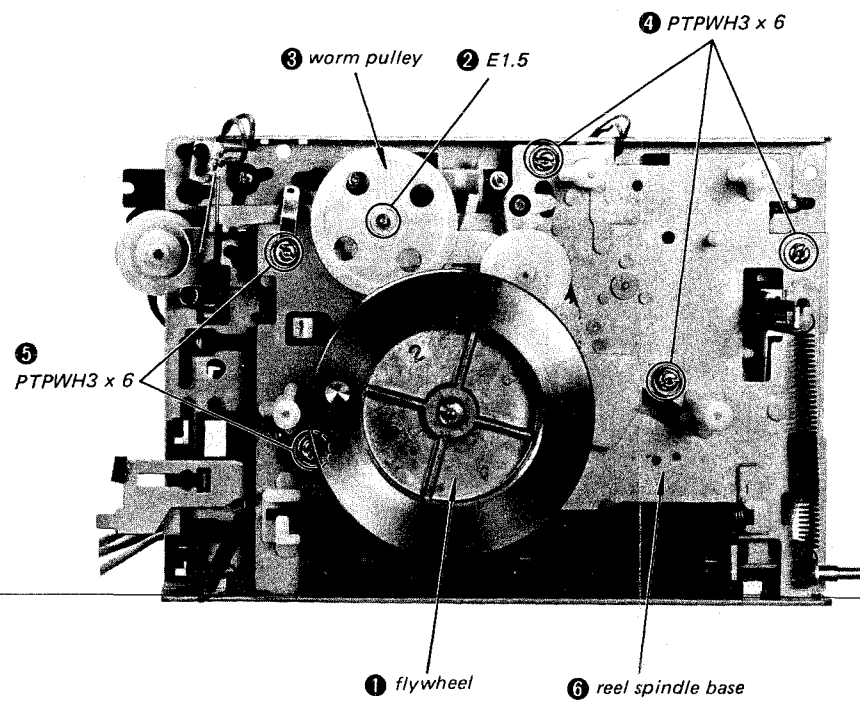

Reel spindle base front view

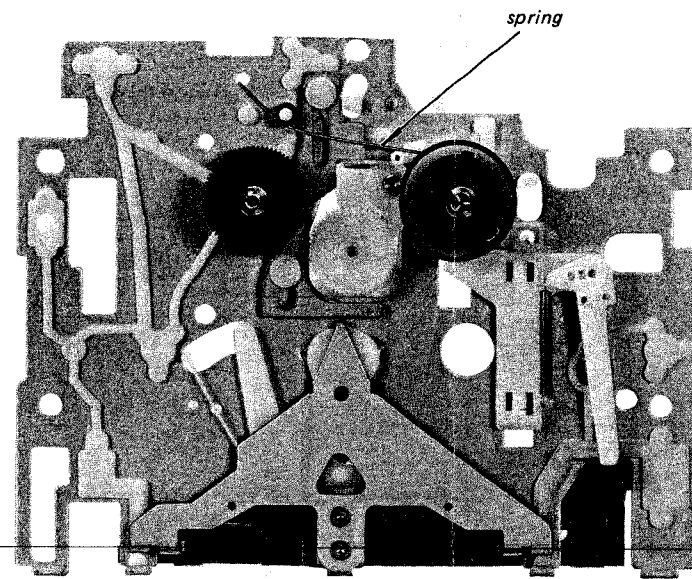

Reel spindle base rear view

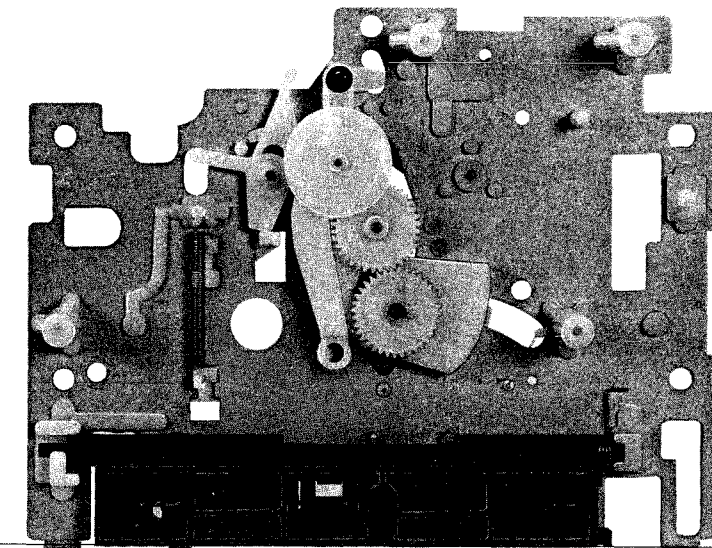

Reel spindle base is not removed.
(front view)

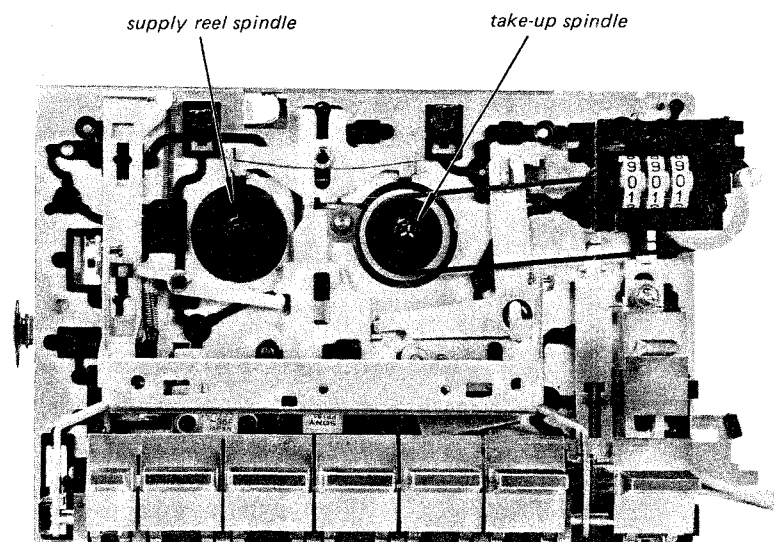

Reel spindle base is removed.
(rear view)

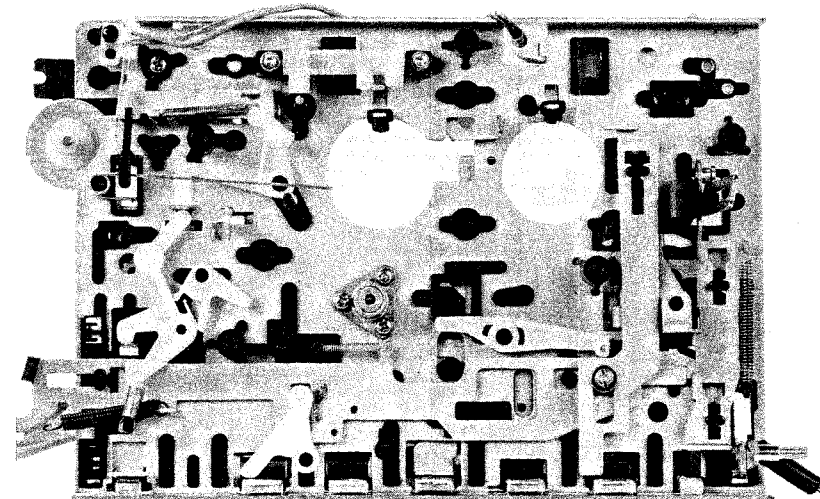

SECTION 3 ADJUSTMENTS

3-1. MECHANICAL ADJUSTMENTS

PRECAUTION

1. Clean the following parts with a denatured-alcohol-moistened swab:

record/playback head	pinch roller
erase head	rubber belts
capstan	idlers
2. Demagnetize the record/playback head with a head demagnetizer.
3. Do not use a magnetized screwdriver for the adjustments.
4. After the adjustments, apply suitable locking compound to the parts adjusted.
5. The adjustments should be performed with the rated power supply voltage unless otherwise noted.

Back Tension Torque Adjustment

— playback mode —

Torque meter	Meter reading
CQ-102	2.0 – 4.5g-cm (0.02 – 0.06 oz-inch)

If necessary, change the spring supply reel spindle
position.

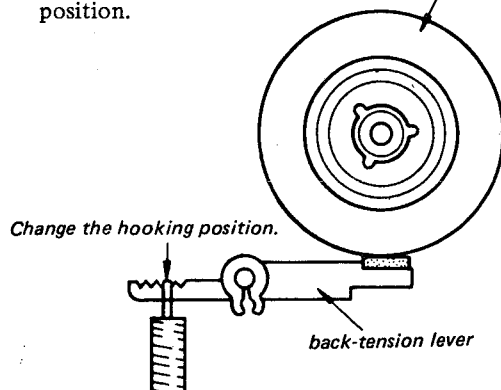

Head Height Adjustment

1. Prepare an adjustment cassette as shown below.

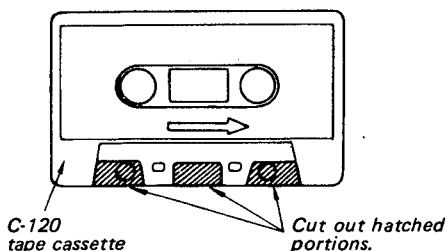

2. In playback mode and viewing from the front, adjust the head heights to eliminate tape curl and tape twist at portions shown by arrows.

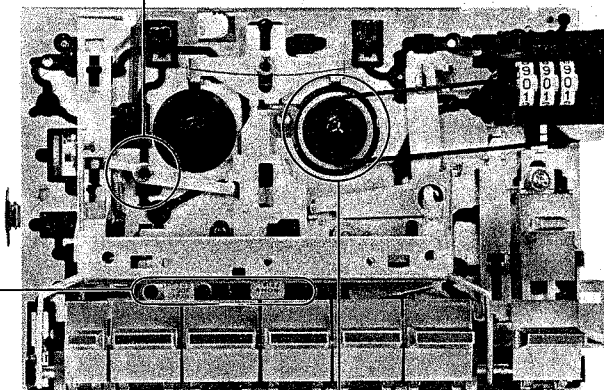
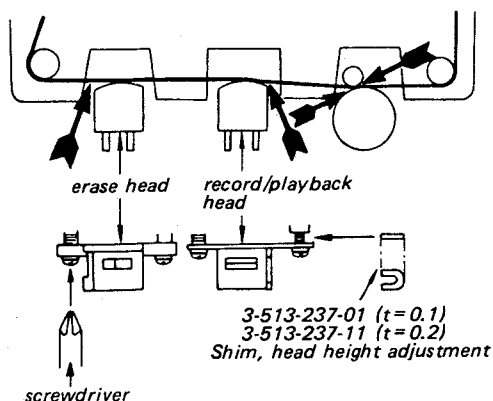

Forward Torque Adjustment

— playback mode —

Torque meter	Meter reading
CQ-102	30 ~ 50g-cm (0.42 – 0.70 oz. inch)

If necessary, change the spring position.

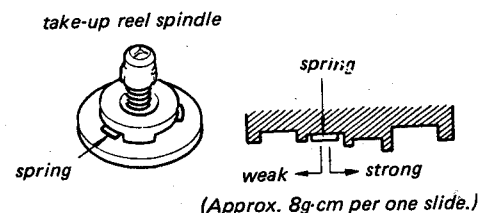

Timing Switch (S1002) Position Adjustment — stop mode —

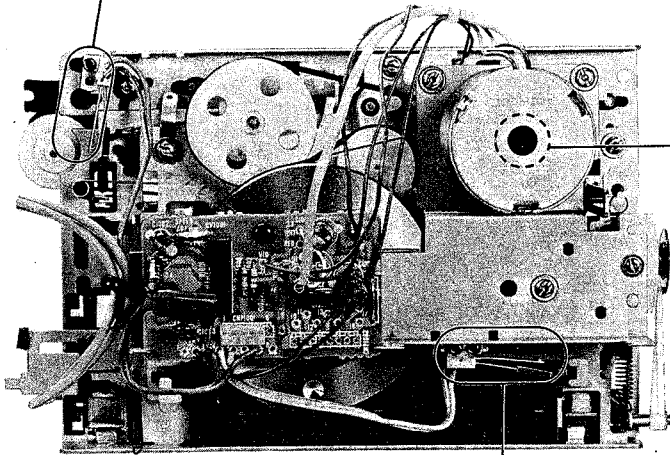
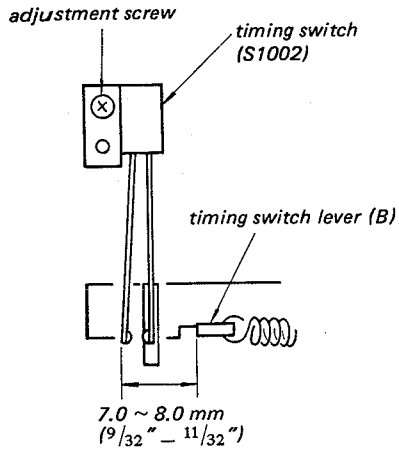

Pulley Height Adjustment — stop mode —

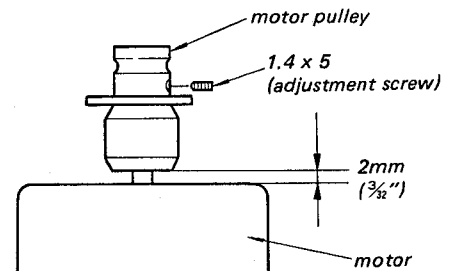

Muting Switch (S1001) Position Adjustment — stop mode —

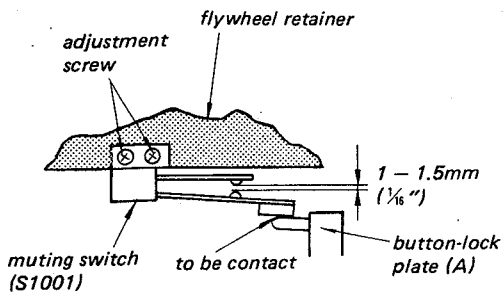

3-2. ELECTRICAL ADJUSTMENTS

Note: The adjustment should be performed in the order given in this service manual. The adjustments should be performed for both L-CH and R-CH.

- Set the EQ switches according to the tape as follows.

Tape	EQ switch
CS-10	TYPE I
CS-25	TYPE II
CS-30	TYPE III

- Switches and controls should be set as follows unless otherwise specified.

DOLBY NR switch: OFF
 EQ switch: TYPE III
 INPUT SELECT switch: LINE

- Standard Record:

Deliver the standard input signal level to the input jack and set the REC LEVEL control to obtain the standard output signal level.

Standard Input Level

	MIC	LINE IN
source impedance	300Ω	10kΩ
input level	0.77mV (-60dB)	0.25V (-10dB)

Standard Output Level

	LINE OUT	HEAD-PHONES
load impedance	47kΩ	8Ω
output level	0.44V (-5dB)	31 mV (-28dB)

Tape Speed Adjustment

Procedure:

Mode: playback

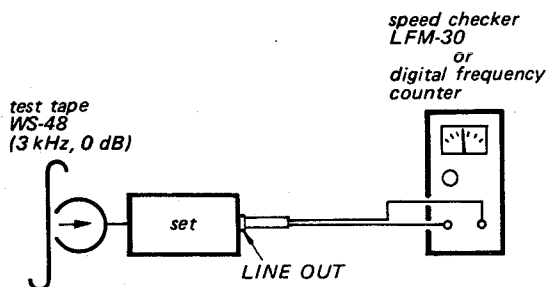

Specification:

Speed checker	Digital frequency counter
-0.6 to +0.6%	2980 - 3020Hz

Frequency difference between the beginning and the end of the tape should be within 0.6% (20Hz).

Adjustment Location:

- servo amp board -

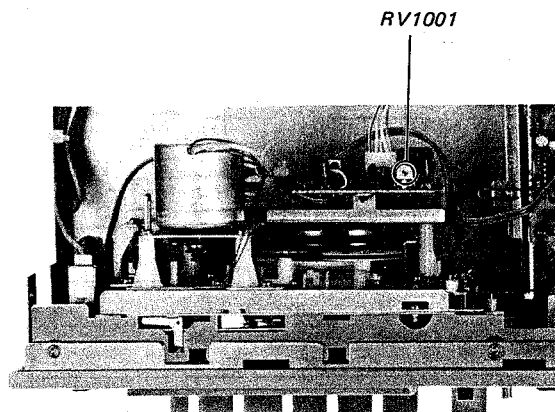

Record/playback Head Azimuth Adjustment

Procedure:

1. Mode: playback

test tape
P-4-A81
(6.3 kHz, -10 dB)

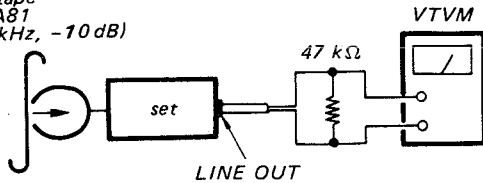

2. Turn the adjustment screw for the maximum output levels. If these levels do not match, turn the adjustment screw until both of output levels match together within 0.5 dB.

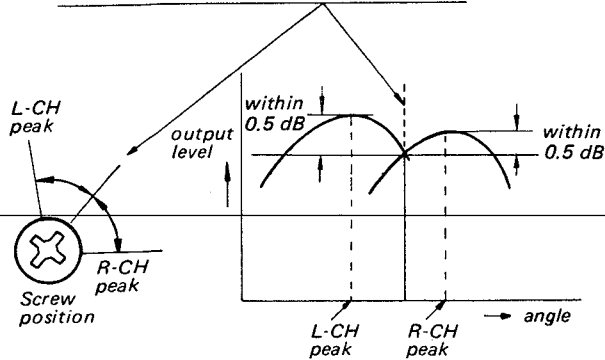

3. Phase Check
Mode: playback

test tape
P-4-A81
(6.3 kHz, -10 dB)

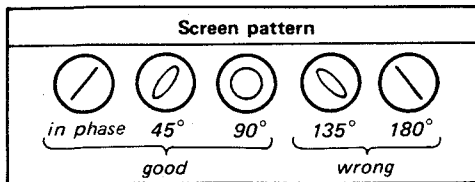
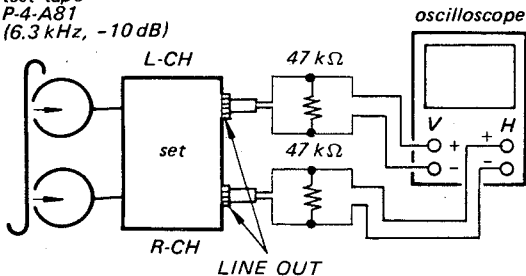

Adjustment Location:

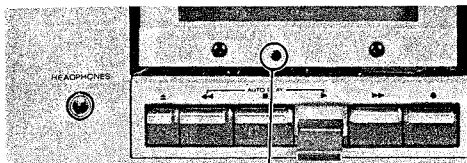

adjustment screw

Playback Level Adjustment

Setting:

TAPE SELECT switch: TYPE I

Procedure:

Mode: playback

test tape
P-4-L81
(333 Hz, 0 dB)

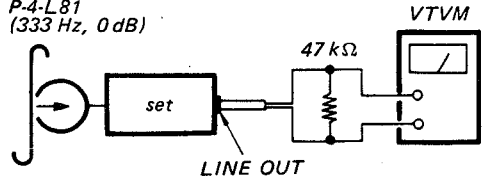

Specification:

LINE OUT level: 0.52 – 0.59V
(–3.5 to –2.5dB)

Level difference between channels:
less than 0.5dB

Level difference from TYPE I:
between –0.5dB and
+0.5dB.

(TAPE SELECT switch: TYPE III)

Check that the LINE OUT level does not change in playback mode while changing the mode from playback to stop several times.

Adjustment Location:

– audio amp board –

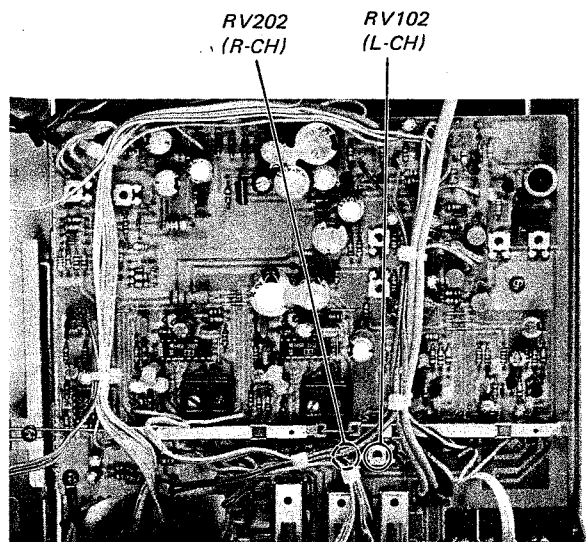

LED Peak Program Meter Calibration

Setting:

REC LEVEL control: LINE IN 1kHz, 0.25 V (-10 dB)
 LINE OUT 0.69 V (-1 dB)

Procedure:

1. Mode: record

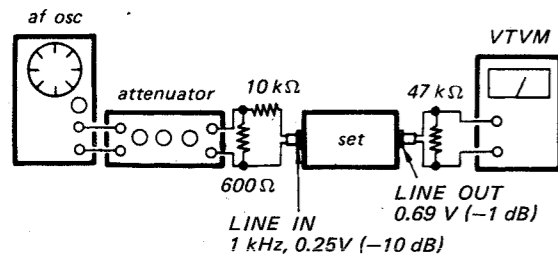

Turn RV161 (L-CH) and RV261 (R-CH), and stop them just when ninth segment from the left goes out.

Adjustment Location:

— audio amp board —

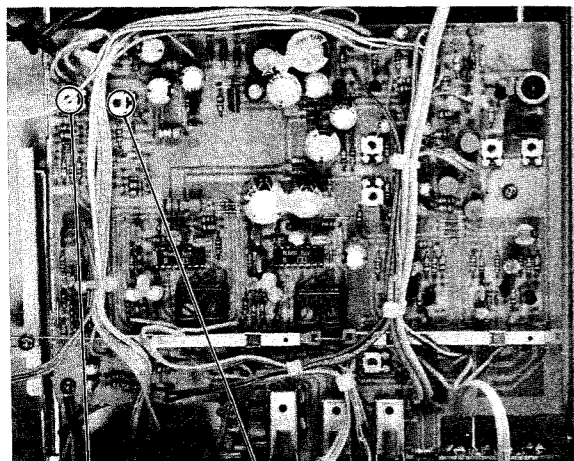

RV261 (R-CH) RV161 (L-CH)

Record Bias Adjustment

Setting:

REC LEVEL control: standard record
 (See page 17.)

Procedure:

1. Mode: record

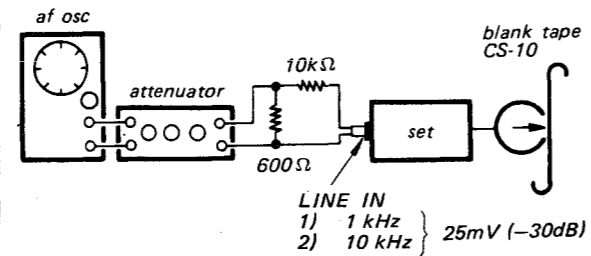

2. Mode: playback

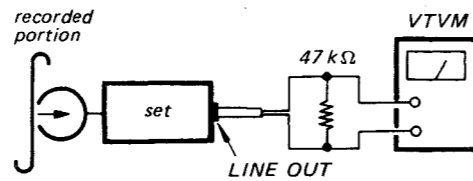

Adjust RV301 (L-CH) and RV302 (R-CH) to make 1kHz and 10kHz signal output levels equal.

Adjustment Location: — audio amp board —

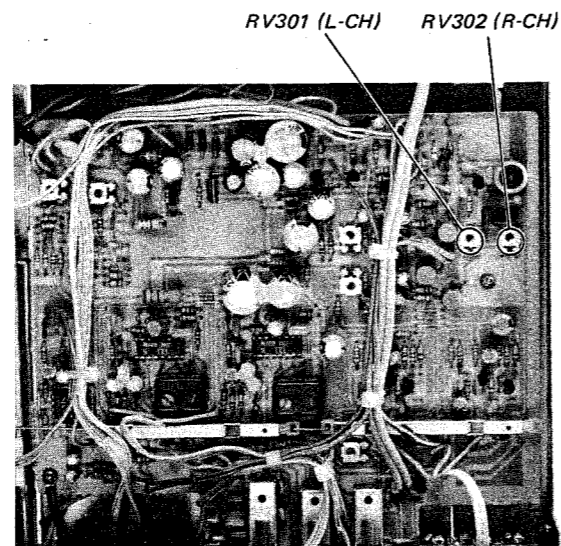

RV301 (L-CH) RV302 (R-CH)

Record Level Adjustment

Setting:

REC LEVEL control: standard record
 (See page 17.)

Procedure:

1. Mode: record

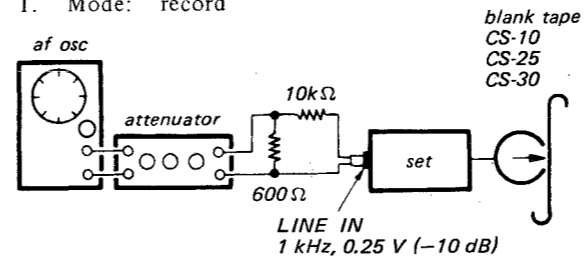

2. Mode: playback

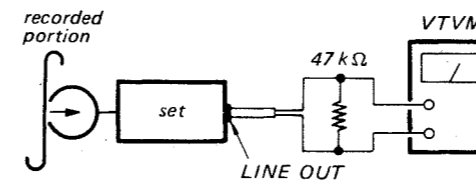

Specification:

tape	LINE OUT level
CS-10	0.41 - 0.46V (-5.5 to -4.5dB)
CS-25 CS-30	0.37 - 0.52V (-6.5 to -3.5dB)

Adjustment Location:

— audio amp board —

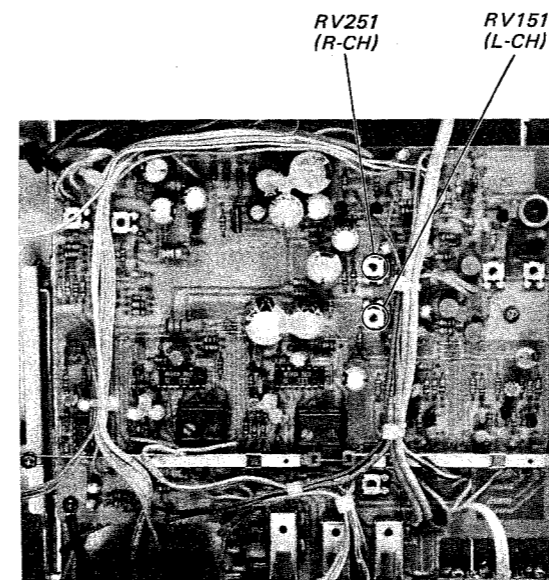

RV251 (R-CH) RV151 (L-CH)

Replacer
 For replac

Q101, 20
 Q102, 20
 Q304: 25

Q141, 24
 Q151, 25
 Q303
 Q305

Q302: 25
 Q405-4C

Q306, 10

IC121, 2;

IC301, 3;

IC401: IV

IC1001:

Record Level Adjustment

Setting:

REC LEVEL control: standard record
(See page 17.)

Procedure:

1. Mode: record

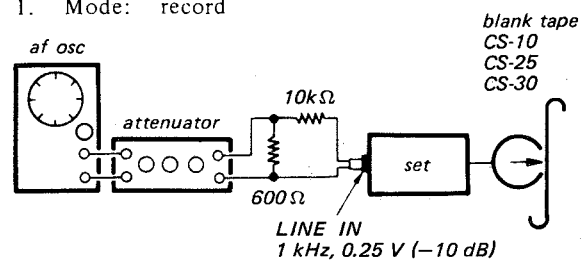

2. Mode: playback

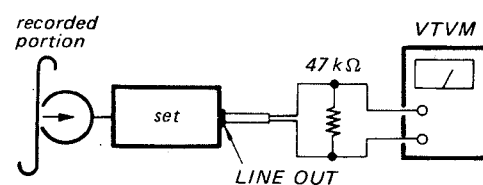

Specification:

tape	LINE OUT level
CS-10	0.41 - 0.46V (-5.5 to -4.5dB)
CS-25	0.37 - 0.52V (-6.5 to -3.5dB)
CS-30	

Adjustment Location:

- audio amp board -

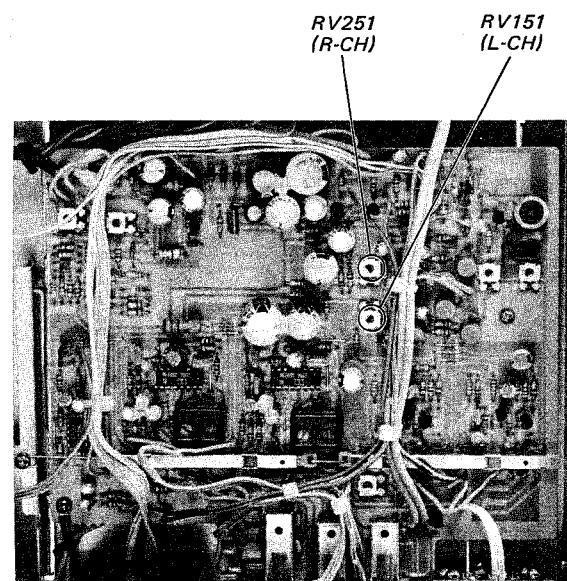

Replacement Semiconductors

For replacement, use semiconductors except in ().

Q101, 201 } : 2SC1362 (2SC900E)
Q102, 202 }
Q304 : 2SC2001 (2SC2001K)

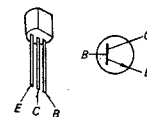

D101, 201 } : 1S1555 (1S953)
D102, 202 }
D103, 203 }
D306, 307 }
D314 }

D301-304 } : 10E2 (1N4002)
D308 }
D310-313 }

D315 : RD5-1EC (RD5-1EB)

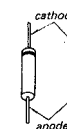

Q141, 241 } : 2SC1364
Q151, 251 }
Q303 }
Q305 }

(2SC945Q)

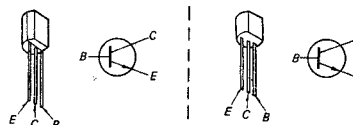

Q302 : 2SA1027R
Q405-408 : 2SA952

(2SA733Q)

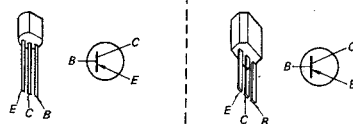

D305 : EQB01-22 (RD22EB)

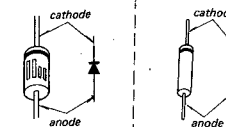

Q306, 1001 : 2SD414 (2SD414Q)

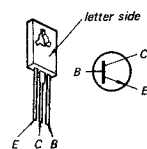

D309 : AR3131D

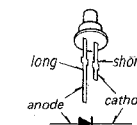

IC121, 221 : NE646B

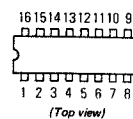

IC301, 302 : μPC4558C

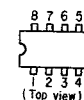

IC401 : MSL9351

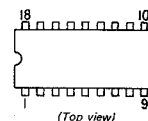

IC1001 : CX069

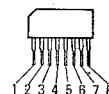

TC-U30 TC-U30

4-2. SCHEMATIC DIAGRAM See page 28 for the notes.

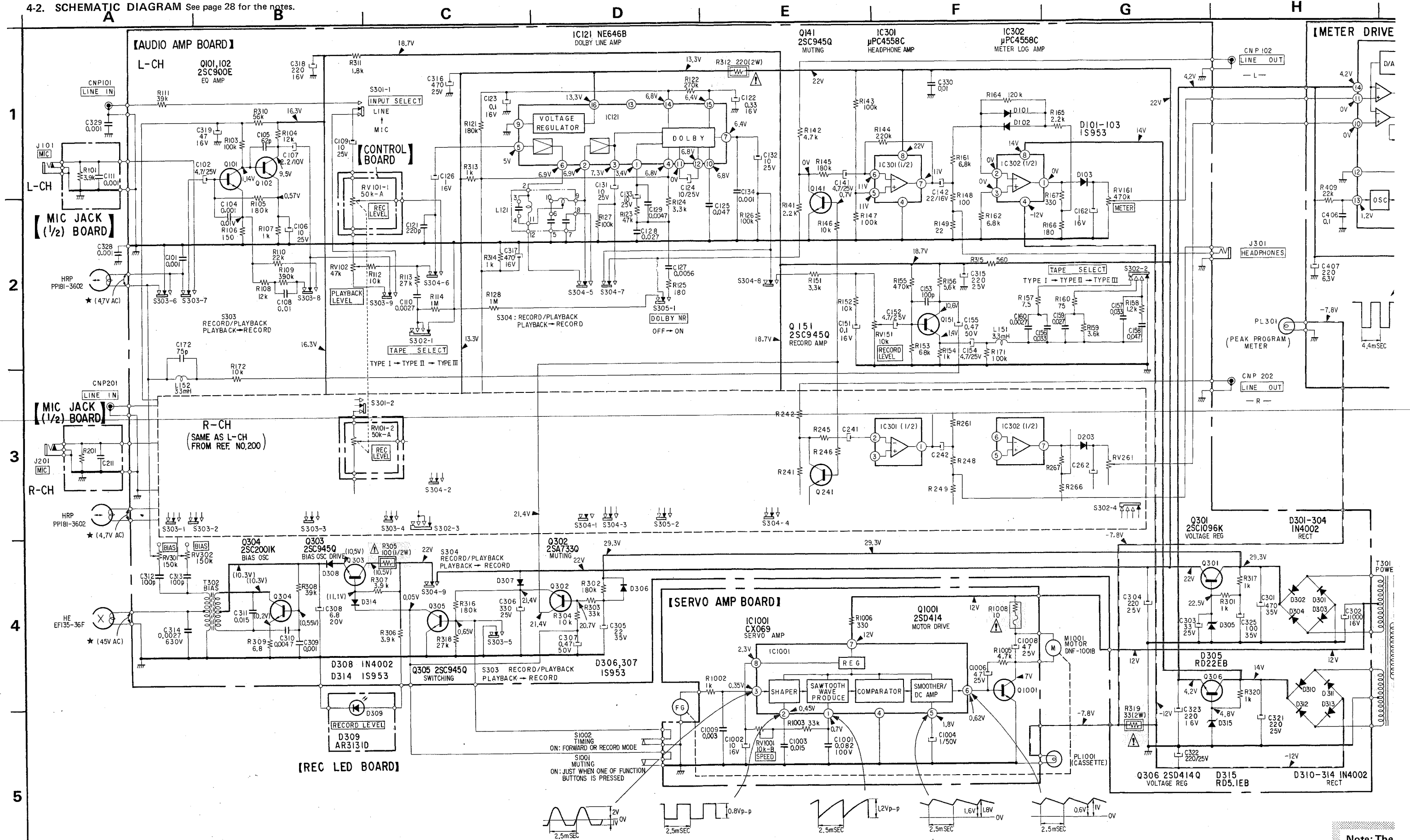

Note: The part

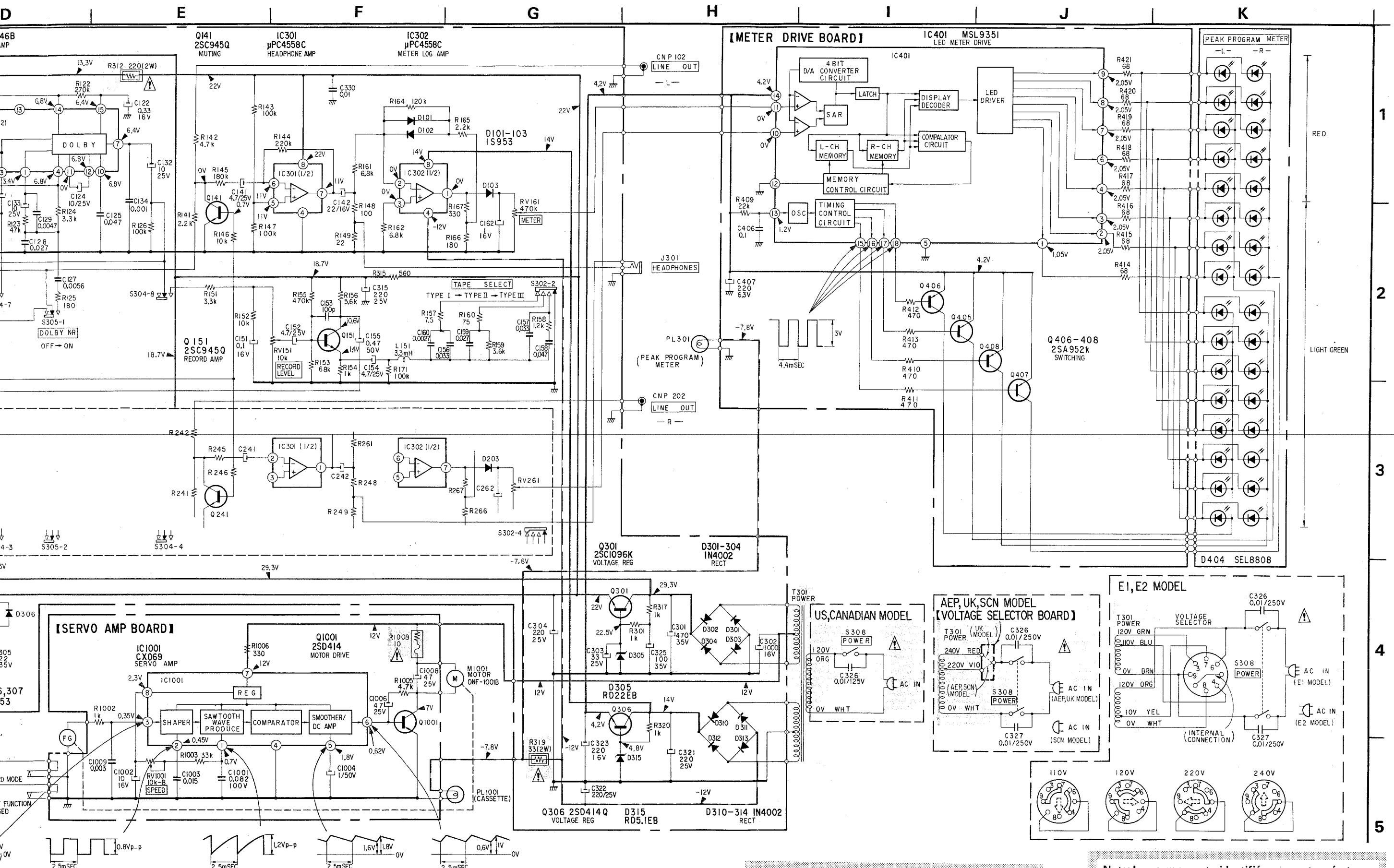

1
2
3
4
5

Note: The components identified by shading and mark are critical for safety. Replace only with part number specified.

Note: Les composants identifiés par un tramé et une marque sont critiques pour la sécurité. Ne les remplacer que par une pièce portant le numéro spécifié.

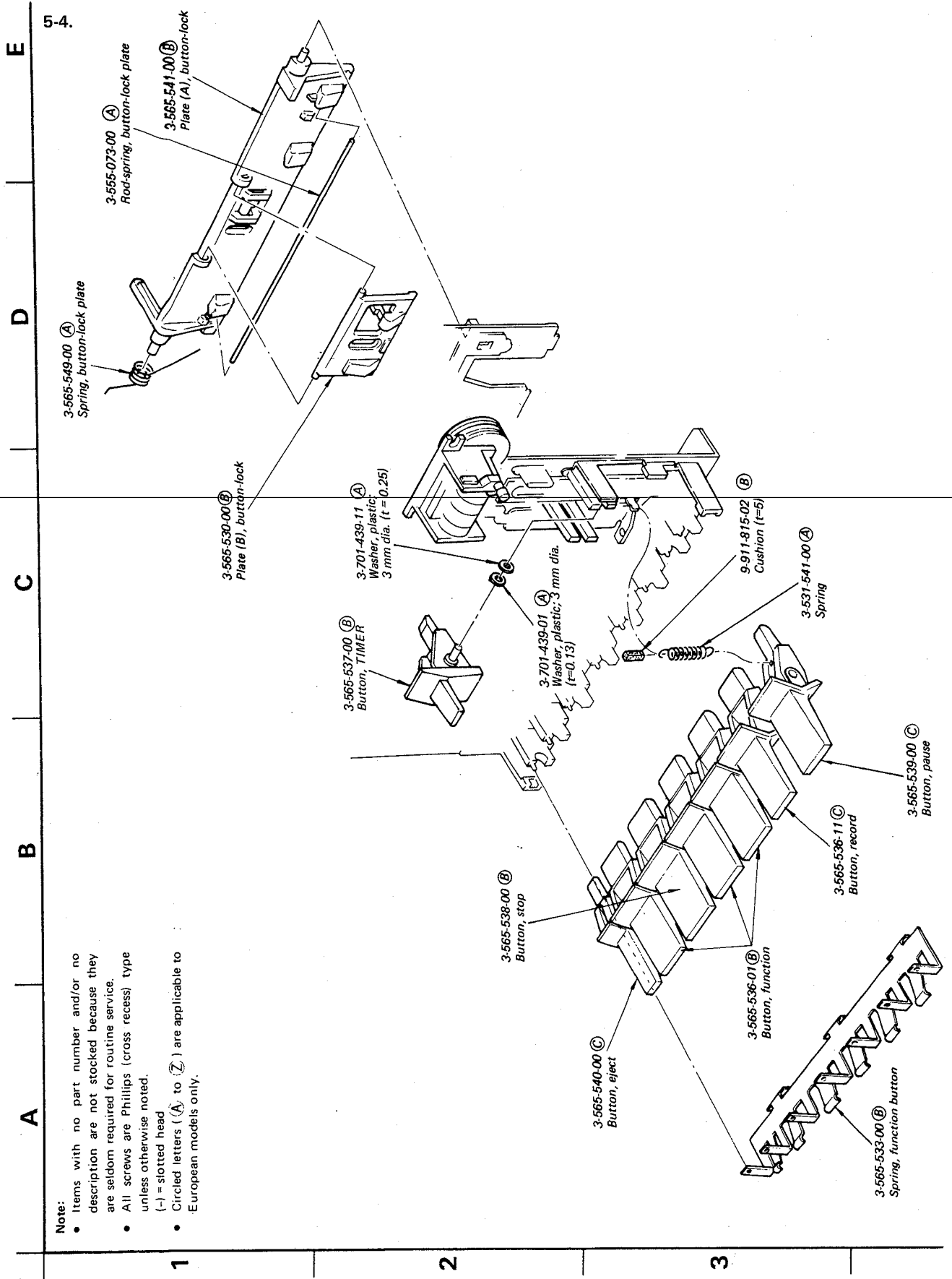

Note:

- Items with no part number and/or no description are not stocked because they are seldom required for routine service.
- All screws are Phillips (cross recess) type unless otherwise noted.
- (-) = slotted head
- Circled letters (A) to (Z) are applicable to European models only.

5.5.

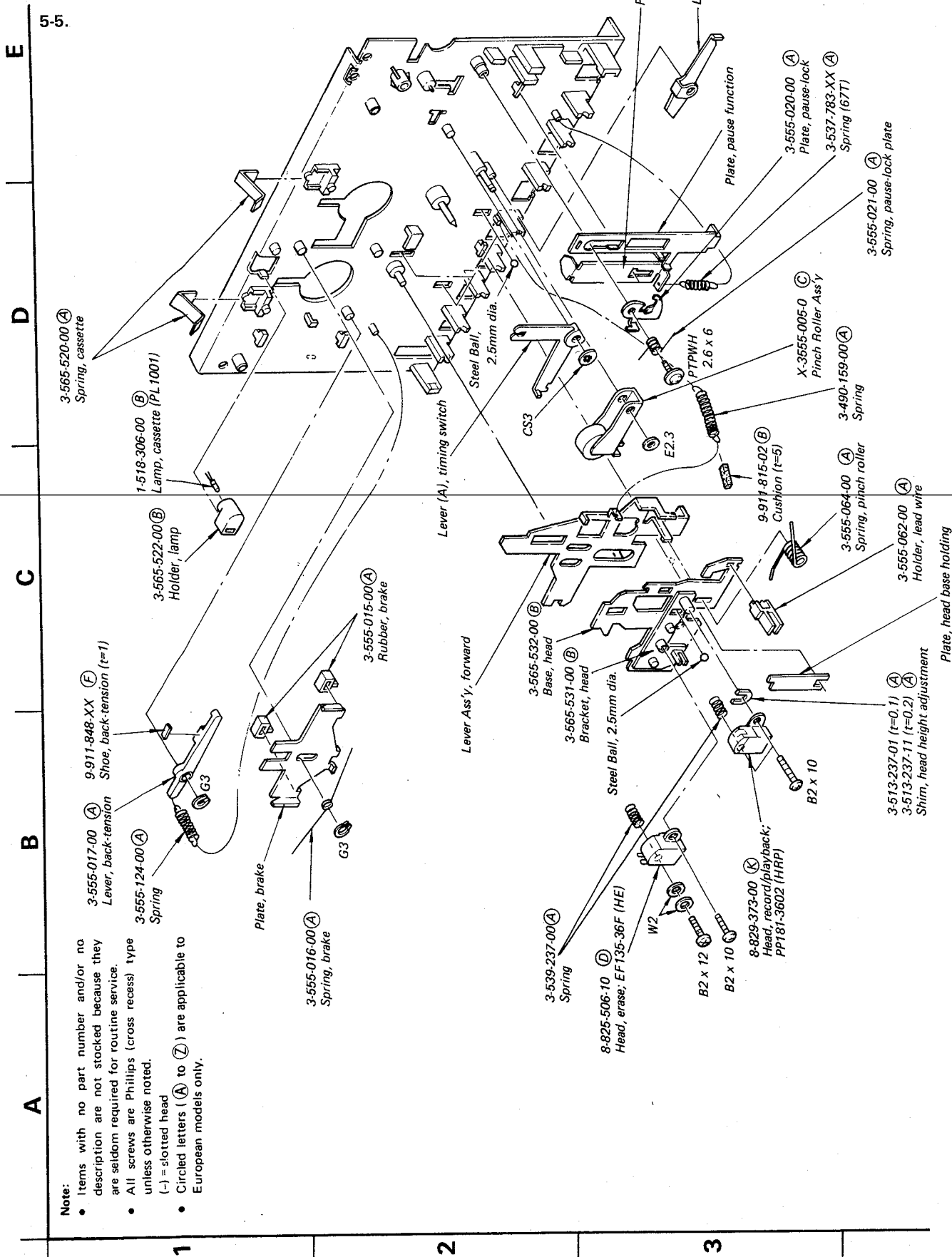

Note:

- Items with no part number and/or no description are not stocked because they are seldom required for routine service.
- All screws are Phillips (cross recess) type unless otherwise noted.
- (-) = slotted head
- Circled letters (A) to (Z) are applicable to European models only.

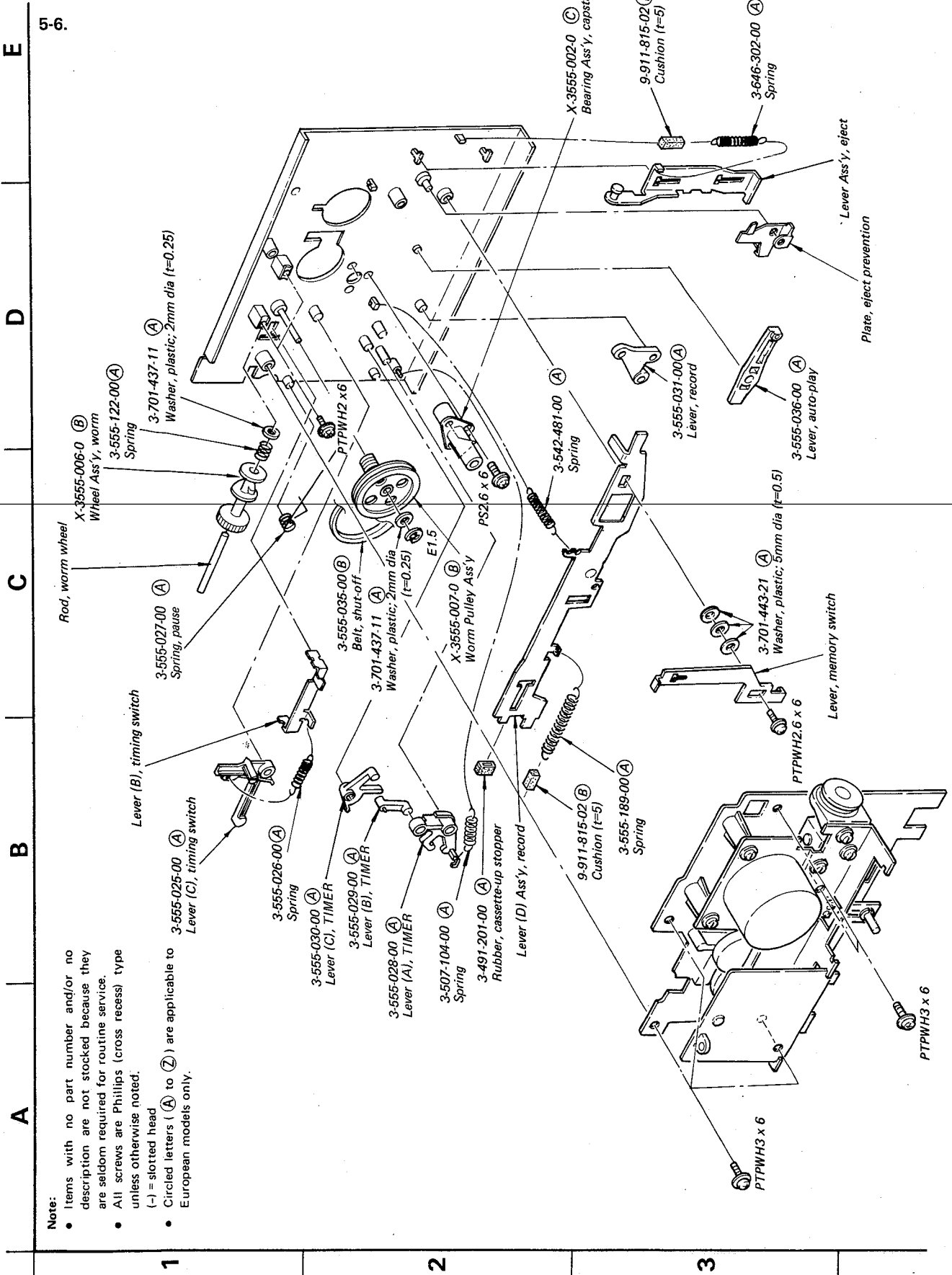

Note:

- Items with no part number and/or no description are not stocked because they are seldom required for routine service.
- All screws are Phillips (cross recess) type unless otherwise noted.
- (-) = slotted head
- Circled letters (A) to (E) are applicable to European models only.

1

2

3

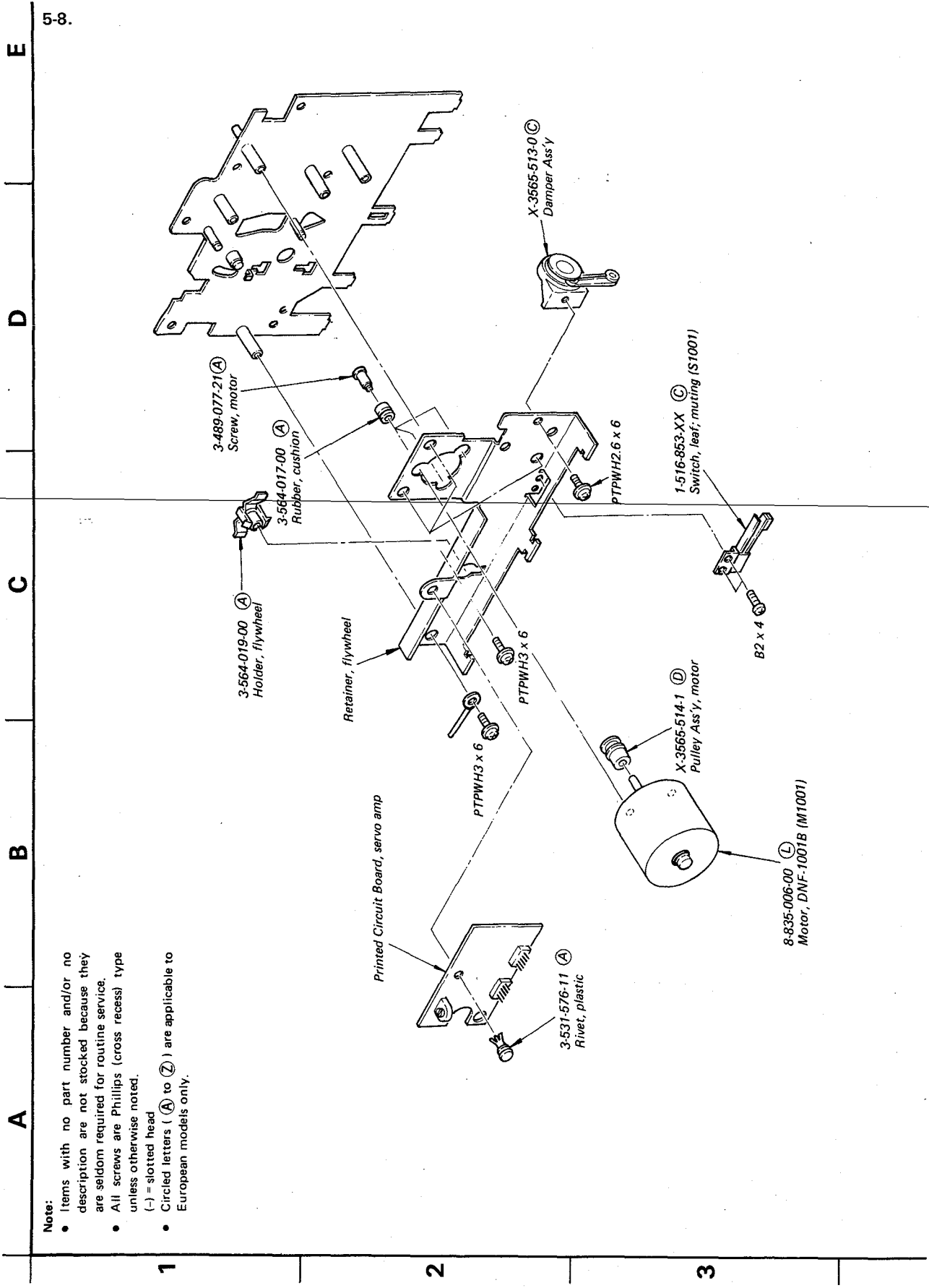

Note:

- Items with no part number and/or no description are not stocked because they are seldom required for routine service.
- All screws are Phillips (cross recess) type unless otherwise noted.
- (-) = slotted head
- Circled letters (A) to (Z) are applicable to European models only.

**SECTION 6
ELECTRICAL PARTS LIST**

Note: Circled letters (A) to (Z) are applicable to European models only.

Ref. No. Part No. Description

SEMICONDUCTORS

Transistors

⇒ Q101, 201)	8-729-665-47	(B) 2SC1362
⇒ Q102, 202)		
⇒ Q141, 241)	8-729-663-47	(B) 2SC1364
⇒ Q151, 251)		
Q301	8-729-316-12	(D) 2SC1061
⇒ Q302	8-729-612-77	(B) 2SA1027R
⇒ Q303	8-729-663-47	(B) 2SC1364
⇒ Q304	8-729-100-13	(B) 2SC2001
⇒ Q305	8-729-663-47	(B) 2SC1364
⇒ Q306	8-729-141-43	(B) 2SD414
Q405-408	8-729-195-23	(B) 2SA952
⇒ Q1001	8-729-141-43	(B) 2SD414

ICs

IC121, 221	8-759-906-46	(G) NE646B
IC301, 302	8-759-145-58	(D) μ PC4558C
IC401	8-759-993-51	(H) MSL9351
IC1001	8-750-690-00	(D) CX069

Diodes

⇒ D101, 201)	8-719-815-55	(B) 1S1555
⇒ D102, 202)		
⇒ D103, 203)		
⇒ D301-304	8-719-200-02	(B) 10E2
⇒ D305	8-719-931-22	(B) EQB01-22
⇒ D306, 307	8-719-815-55	(B) 1S1555
⇒ D308	8-719-200-02	(B) 10E2
D309	1-800-960-11	(B) AR3131D
⇒ D310-313	8-719-200-02	(B) 10E2
⇒ D314	8-719-815-55	(B) 1S1555
⇒ D315	8-719-151-77	(B) RD5-1EC
D404	1-800-956-11	(K) SEL8808

COILS

L121, 221	1-231-576-00	(C) Filter, MPX
L151, 251	1-407-962-00	(B) 3.3 mH, microinductor
L152, 252	1-407-964-00	(B) 33 mH, microinductor

⇒: Due to standardization, interchangeable replacements may be substituted for parts specified in the diagrams.

Note: The components identified by shading and mark Δ are critical for safety. Replace only with part number specified.

Ref. No. Part No. Description

TRANSFORMERS

T301	Δ 1-446-520-00	(A) Power (US, Canadian model)
T301	Δ 1-446-522-00	(A) Power (E model)
T301	Δ 1-446-523-00	(P) Power (AEP, SCN, UK model)
T302	1-405-856-00	(B) Osc

CAPACITORS

All capacitors are in μ F and ceramic unless otherwise noted. 50WV or less are not indicated except for electrolytics and tantalums. pF: μ F, elect: electrolytic

C101, 201	1-102-074-00	(A) 0.001		
C102, 202	1-131-419-00	(B) 2.2	10 V	tantalum
C104, 204	1-102-074-00	(A) 0.001		
C105, 205	1-101-886-00	(A) 62p		
C106, 206	1-121-398-00	(B) 10	25 V	elect
C107, 207	1-121-726-00	(B) 0.47	50 V	elect
C108, 208	1-108-579-00	(B) 0.01		mylar
C109, 209	1-121-398-00	(B) 10	25 V	elect
C110, 210	1-108-565-00	(B) 0.0027		mylar
C111, 211	1-102-074-00	(A) 0.001		
C121, 221	1-102-110-00	(A) 220p		
C122, 222	1-131-405-00	(B) 0.33	16 V	tantalum
C123, 223	1-131-451-00	(B) 0.1	16 V	tantalum
C124, 224	1-121-398-00	(B) 10	25 V	elect
C125, 225	1-108-246-00	(B) 0.047		mylar
C126, 226	1-131-347-00	(B) 1	16 V	tantalum
C127, 227	1-108-573-00	(B) 0.0056		mylar
C128, 228	1-108-359-00	(B) 0.027		mylar
C129, 229	1-108-571-00	(B) 0.0047		mylar
C131, 231	1-121-398-00	(B) 10	25 V	elect
C132, 232				
C133, 233				
C134, 234	1-102-074-00	(A) 0.001		
C141, 241	1-121-395-00	(B) 4.7	25 V	elect
C142, 242	1-121-479-00	(B) 22	16 V	elect
C151, 251	1-131-451-00	(B) 0.1	16 V	tantalum
C152, 252	1-121-395-00	(B) 4.7	25 V	elect
C153, 253	1-102-106-00	(A) 100p		
C154, 254	1-121-395-00	(B) 4.7	25 V	elect

Note: Les composants identifiés par un tramé et une marque Δ sont critiques pour la sécurité. Ne les remplacer que par une pièce portant le numéro spécifié.

Note: Circled letters (A to Z) are applicable to European models only.

Ref. No.	Part No.	Description
C155, 255	1-121-726-00 (B) 0.47	50 V elect
C156, 256	1-108-591-00 (B) 0.033	mylar
C157, 257		
C158, 258	1-108-246-00 (B) 0.047	mylar
C159, 259	1-108-359-00 (B) 0.027	mylar
C160, 260	1-108-565-00 (B) 0.0027	mylar
C162, 262	1-131-347-00 (B) 1	16 V tantalum
C172, 272	1-101-890-00 (A) 75p	
C301	1-121-361-00 (B) 470	35 V elect
C302	1-121-245-00 (B) 1000	16 V elect
C303	1-121-404-00 (B) 33	25 V elect
C304	1-121-422-00 (B) 220	25 V elect
C305	1-121-622-00 (B) 22	35 V elect
C306	1-121-654-00 (B) 330	25 V elect
C307	1-121-726-00 (B) 0.47	50 V elect
C308	1-131-234-00 (B) 6.8	20 V tantalum
C309	1-108-227-00 (A) 0.001	mylar
C310	1-108-234-00 (A) 0.0047	mylar
C311	1-108-379-00 (A) 0.015	100 V mylar
C312, 313	1-107-169-00 (B) 100p	500 V mica
C314	1-129-928-00 (B) 0.0027	630 V film
C315	1-121-422-00 (B) 220	25 V elect
C316	1-121-733-00 (B) 470	25 V elect
C317	1-121-426-00 (B) 470	16 V elect
C318	1-119-135-00 (B) 220	16 V elect
C319	1-121-409-00 (B) 47	16 V elect
C321, 322	1-121-422-00 (B) 220	25 V elect
C323	1-119-135-00 (B) 220	16 V elect
C325	1-121-357-00 (B) 100	35 V elect
C326	△1-161-749-00 0.01	125 V (US, Canadian model)
C326, 327	△1-130-196-00 (D) 0.01	250 V film (AEP, SCN, UK, E model)
C328, 329	1-102-074-00 (A) 0.001	
C330	1-108-579-00 (B) 0.01	mylar
C406	1-108-251-00 (B) 0.1	mylar
C407	1-123-465-00 (B) 220	6.3 V elect

Ref. No.	Part No.	Description
C1001	1-130-134-00 (B) 0.082	100 V film
C1002	1-123-316-00 (B) 10	16 V elect
C1003	1-108-240-00 (B) 0.015	50 V mylar
C1004	1-123-352-00 (B) 1	50 V elect
C1006, 1008	1-123-332-00 (B) 47	25 V elect

RESISTORS

All resistors in ohms. Common 1/4W carbon resistors are omitted. Refer to the list on page 40 for their part numbers. (kΩ: 1000Ω, MΩ: 1000 kΩ)

R305	1-206-640-00 (A) 330	1/2 W metal oxide
R312	△1-206-648-00 (B) 220	2 W metal oxide (nonflammable)
R319	△1-206-475-00 (B) 33	2 W metal oxide (nonflammable)
R1001	1-214-765-00 (A) 33 k	1/4W(1%) metal oxide
R1008	△1-217-523-00 (B) 10	1/4 W fusible
RV101	1-226-676-00 (E)	Variable, 50 k-A; REC LEVEL

RV102, 202	1-226-238-00 (B)	adjustable, 50 k-B; playback level
RV151, 251	1-226-236-00 (B)	adjustable, 10 k-B; record level
RV161, 261	1-226-241-00 (B)	adjustable, 470 k-B; meter
RV301, 302	1-226-478-00 (B)	adjustable, 150 k-B; bias
RV1001	1-226-431-00 (B)	adjustable, 10 k-B; tape speed

SWITCHES

S301	1-553-083-00 (D)	Lever-slide, INPUT SELECT
S302	1-553-082-00 (C)	Lever-slide, TAPE SELECT
S303	1-552-982-00 (C)	Lever-slide, record/playback
S304	1-552-983-00 (C)	Lever-slide, record/playback
S305	1-553-083-00 (D)	Lever-slide, DOLBY NR
S308	△1-553-084-00	Pushbutton, POWER (US, Canadian model)
S308	△1-553-085-00 (D)	Pushbutton, POWER (AEP, SCN, UK, E model)
S1001, 1002	1-516-853-XX (C)	Leaf, muting, timing

MISCELLANEOUS

CNP101,201	1-551-629-00 (D)	Cord, with plug; LINE OUT (AEP, SCN, UK, E model)
CNP101,201	1-551-911-00	Cord, with plug; LINE OUT (US, Canadian model)

Note: The components identified by shading and mark △ are critical for safety. Replace only with part number specified.

Note: Les composants identifiés par un tramé et une marque △ sont critiques pour la sécurité. Ne les remplacer que par une pièce portant le numéro spécifié.

Note: Circled letters (A to Z) are applicable to European models only.

<u>Ref. No.</u>	<u>Part No.</u>	<u>Description</u>
CNP102,202	1-551-913-00	(D) Cord, with plug; LINE IN (AEP, SCN, UK, E model)
CNP102,202	1-551-912-00	Cord, connection; LINE IN (US, Canadian model)
HE	8-825-506-10	(D) Head, erase; EF135-36F
HRP	8-829-373-00	(K) Head, record/playback; PP181-3602
J101, 201	1-507-608-00	(C) Jack, MIC
J301	1-507-640-00	(C) Jack, HEADPHONES
M1001	8-835-006-00	(L) Motor, DNF-1001B
PL1001	1-518-306-00	(B) Lamp, 8 V 50 mA; cassette
	1-548-536-21	(D) Counter, tape
	△1-551-628-00	Cord, power; parallel-blade plug (US, Canadian, E2 model)
	△1-551-896-00	(E) Cord, power; euro-plug (AEP, E1 model)
	△1-551-908-00	(E) Cord, power (SCN model)
	△1-551-962-00	(E) Cord, power (UK model)
	△1-552-026-00	Voltage Selector (E model)

ACCESSORIES AND PACKING MATERIALS	
<u>Part No.</u>	<u>Description</u>
X-3701-105-0	(A) Tips Ass'y, head cleaning
△1-551-966-00	(E) Adaptor, power cord (AEP, E model)
△1-551-967-00	(E) Adaptor, power cord (UK model)
3-588-118-00	(C) Carton (AEP, SCN, E model)
3-588-119-00	(C) Carton (US, Canadian, UK model)
3-588-120-00	(C) Cushion
3-701-630-00	(A) Bag, plastic; instruction manual
3-770-951-11	(D) Manual, instruction (AEP, E, UK, SCN model)
3-770-951-21	Manual, instruction (US model)
3-770-951-21	Manual, instruction (Canadian model)
3-794-589-21	
3-793-828-11	(B) Card, cassette caution
3-794-233-21	(A) Separate Sheet, consumer products
4-818-924-00	(B) Bag, plastic

Note: The components identified by shading and mark △ are critical for safety. Replace only with part number specified.

Note: Les composants identifiés par un trame et une marque △ sont critiques pour la sécurité. Ne les remplacer que par une pièce portant le numéro spécifié.

1/4 WATT CARBON RESISTORS (A)

Note: Circled letter (A) is applicable to European models only.

Ω	Part No.	Ω	Part No.	Ω	Part No.	Ω	Part No.	Ω	Part No.	Ω	Part No.	Ω	Part No.
1.0	1-246-401-00	10	1-246-425-00	100	1-246-449-00	1.0k	1-246-473-00	10k	1-246-497-00	100k	1-246-521-00	1.0M	1-246-545-00
1.1	1-246-402-00	11	1-246-426-00	110	1-246-450-00	1.1k	1-246-474-00	11k	1-246-498-00	110k	1-246-522-00	1.1M	1-210-814-00
1.2	1-246-403-00	12	1-246-427-00	120	1-246-451-00	1.2k	1-246-475-00	12k	1-246-499-00	120k	1-246-523-00	1.2M	1-210-815-00
1.3	1-246-404-00	13	1-246-428-00	130	1-246-452-00	1.3k	1-246-476-00	13k	1-246-500-00	130k	1-246-524-00	1.3M	1-210-816-00
1.5	1-246-405-00	15	1-246-429-00	150	1-246-453-00	1.5k	1-246-477-00	15k	1-246-501-00	150k	1-246-525-00	1.5M	1-210-817-00
1.6	1-246-406-00	16	1-246-430-00	160	1-246-454-00	1.6k	1-246-478-00	16k	1-246-502-00	160k	1-246-526-00	1.6M	1-210-818-00
1.8	1-246-407-00	18	1-246-431-00	180	1-246-455-00	1.8k	1-246-479-00	18k	1-246-503-00	180k	1-246-527-00	1.8M	1-210-819-00
2.0	1-246-408-00	20	1-246-432-00	200	1-246-456-00	2.0k	1-246-480-00	20k	1-246-504-00	200k	1-246-528-00	2.0M	1-210-820-00
2.2	1-246-409-00	22	1-246-433-00	220	1-246-457-00	2.2k	1-246-481-00	22k	1-246-505-00	220k	1-246-529-00	2.2M	1-210-821-00
2.4	1-246-410-00	24	1-246-434-00	240	1-246-458-00	2.4k	1-246-482-00	24k	1-246-506-00	240k	1-246-530-00	2.4M	1-244-754-00
2.7	1-246-411-00	27	1-246-435-00	270	1-246-459-00	2.7k	1-246-483-00	27k	1-246-507-00	270k	1-246-531-00	2.7M	1-244-755-00
3.0	1-246-412-00	30	1-246-436-00	300	1-246-460-00	3.0k	1-246-484-00	30k	1-246-508-00	300k	1-246-532-00	3.0M	1-244-756-00
3.3	1-246-413-00	33	1-246-437-00	330	1-246-461-00	3.3k	1-246-485-00	33k	1-246-509-00	330k	1-246-533-00	3.3M	1-244-757-00
3.6	1-246-414-00	36	1-246-438-00	360	1-246-462-00	3.6k	1-246-486-00	36k	1-246-510-00	360k	1-246-534-00	3.6M	1-244-758-00
3.9	1-246-415-00	39	1-246-439-00	390	1-246-463-00	3.9k	1-246-487-00	39k	1-246-511-00	390k	1-246-535-00	3.9M	1-244-759-00
4.3	1-246-416-00	43	1-246-440-00	430	1-246-464-00	4.3k	1-246-488-00	43k	1-246-512-00	430k	1-246-536-00	4.3M	1-244-760-00
4.7	1-246-417-00	47	1-246-441-00	470	1-246-465-00	4.7k	1-246-489-00	47k	1-246-513-00	470k	1-246-537-00	4.7M	1-244-761-00
5.1	1-246-418-00	51	1-246-442-00	510	1-246-466-00	5.1k	1-246-490-00	51k	1-246-514-00	510k	1-246-538-00	5.1M	1-244-762-00
5.6	1-246-419-00	56	1-246-443-00	560	1-246-467-00	5.6k	1-246-491-00	56k	1-246-515-00	560k	1-246-539-00		
6.2	1-246-420-00	62	1-246-444-00	620	1-246-468-00	6.2k	1-246-492-00	62k	1-246-516-00	620k	1-246-540-00		
6.8	1-246-421-00	68	1-246-445-00	680	1-246-469-00	6.8k	1-246-493-00	68k	1-246-517-00	680k	1-246-541-00		
7.5	1-246-422-00	75	1-246-446-00	750	1-246-470-00	7.5k	1-246-494-00	75k	1-246-518-00	750k	1-246-542-00		
8.2	1-246-423-00	82	1-246-447-00	820	1-246-471-00	8.2k	1-246-495-00	82k	1-246-519-00	820k	1-246-543-00		
9.1	1-246-424-00	91	1-246-448-00	910	1-246-472-00	9.1k	1-246-496-00	91k	1-246-520-00	910k	1-246-544-00		

HARDWARE NOMENCLATURE

Screw:

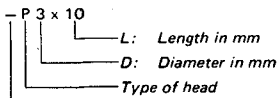

Unless otherwise indicated, it means cross-recessed head (Phillips type).

Nut, Washer, Retaining ring:

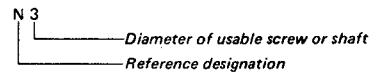

Reference Designation	Shape	Description	Remarks
SCREWS			
P		pan-head screw	binding-head (B) screw for replacement
PWH		pan-head screw with washer face	binding-head (B) screw and flat washer for replacement
PS PSP		pan-head screw with spring washer	binding-head (B) screw and spring washer for replacement
PSW PSPW		pan-head screw with spring and flat washers	binding-head (B) screw and spring and flat washers for replacement
R		round-head screw	binding-head (B) screw for replacement
K		flat-countersunk-head screw	
RK		oval-countersunk-head screw	
B		binding-head screw	
T		truss-head screw	binding-head (B) screw for replacement
F		flat-fillister-head screw	
RF		fillister-head screw	
BV		braizer-head screw	

Reference Designation	Shape	Description	Remarks
SELF-TAPPING SCREWS			
TA		self-tapping screw	ex: TA, P 3 x 10
PTP		pan-head self-tapping screw	binding-head self-tapping (TA, B) screw for replacement
PTPWH		pan-head self-tapping screw with washer face	binding-head self-tapping (TA, B) screw and flat washer for replacement
PTTWH		pan-head thread-rolling screw with washer face	binding-head (B) screw and flat washer for replacement
SET SCREWS			
SC		set screw	
SC		hexagon-socket set screw	ex: SC 2.6 x 4, hexagon socket
NUT			
N		nut	
WASHERS			
W		flat washer	
SW		spring washer	
LW		internal-tooth lock washer	ex: LW3, internal
LW		external-tooth lock washer	ex: LW3, external
RETAINING RINGS			
E		retaining ring	
G		grip-type retaining ring	